



This manual is for reference and historical purposes, all rights reserved.

This page is copyright© by M. Butkus, NJ.

This page may not be sold or distributed without the expressed permission of the producer

I have no connection with any camera company

On-line camera manual library

This is the full text and images from the manual. This may take 3 full minutes for the PDF file to download.

If you find this manual useful, how about a donation of \$3 to: M. Butkus, 29 Lake Ave., High Bridge, NJ 08829-1701 and send your e-mail address so I can thank you. Most other places would charge you \$7.50 for a electronic copy or \$18.00 for a hard to read Xerox copy.

This will allow me to continue to buy new manuals and pay their shipping costs.

It'll make you feel better, won't it?

**If you use Pay Pal or wish to use your credit card,
click on the secure site on my main page.**

PayPal Name Lynn@butkus.org

Nikon
Autofocus Speedlight

SB-24

Instruction Manual

CONTENTS

FOREWORD	4	USABLE TTL AUTO FLASH ACCORDING TO LENS/EXPOSURE MODE/METERING SYSTEM COMBINATION	29	AUT
NOTES	5	MATRIX BALANCED FILL-FLASH OPERATION	30-45	F-
NOMENCLATURE	6-8	In Programmed Auto Exposure Mode	32-34	NON
USABLE FLASH MODES WITH YOUR CAMERA	9-11	In Shutter-Priority Auto Exposure Mode	35-38	F-
TTL AUTO [i]	9	In Aperture-Priority Exposure Mode	39-42	EX
USABLE TTL FLASH MODES	10	In Manual Exposure Mode	43-45	USA
NON-TTL AUTO [A]	11	FLASH EXPOSURE COMPENSATION	46-47	IN
MANUAL [M]	11	REAR-CURTAIN SYNC FLASH—		MAI
REPEATING FLASH [SR]	11	For Natural Light Flows	48	S
FLASH SYNC MODE SELECTOR	11	SHUTTER SPEED/APERTURE FOR EACH EXPOSURE MODE	49	M
READY-LIGHT INDICATIONS	12-13	TTL AUTO FLASH WITH NIKON F-401s/N4004s	50-56	REF
READY-LIGHT WARNING FUNCTIONS	12-13	SHOOTING BRIGHT AND DARK SUBJECTS	50-55	GUI
SETTING POWER SWITCH	14	Programmed TTL Auto Flash—In Program or		DIF
EXPOSURE COMPENSATION	15-16	Shutter-Priority Auto Exposure Mode	51-53	B
FLASH SIDE COMPENSATION	15	TTL Auto Flash—In Aperture Priority Auto or		U
CAMERA SIDE COMPENSATION	16	Manual Exposure Mode	54-55	MU
LIGHTING MANIPULATION	16	AUTOMATIC BALANCED FILL-FLASH	56	T
SETTING BEFORE SHOOTING	17-24	TTL AUTO FLASH WITH OTHER CAMERAS		A
INSTALLING BATTERIES	17	(with Nikon F-501/N2020, F-301/N2000, FA, FE2 or FG)	57-63	
ATTACHING FLASH UNIT TO		PROGRAMMED TTL AUTO FLASH (with Nikon F-501/N2020		
CAMERA ACCESSORY SHOE	18-19	or F-301/N2000 in Programmed or Shutter-Priority		
ADJUSTING FLASH HEAD	20	Auto Exposure Mode)	57-59	
SETTING ISO FILM SPEED	20-21	TTL AUTO FLASH	60-61	
SETTING ANGLE OF COVERAGE	22-24	EXPOSURE COMPENSATION WITH CAMERA'S		
TTL AUTO FLASH WITH		EXPOSURE DIAL	62	
NIKON F4 OR F-871/N8008	25-49	FILL-FLASH IN TTL FLASH MODE	63	
FILL-FLASH PHOTOGRAPHY	26			
MATRIX BALANCED FILL-FLASH	27			
CENTER-WEIGHTED FILL-FLASH	28			
STANDARD TTL FLASH	28			

AUTOFOCUS FLASH PHOTOGRAPHY (with Nikon F4, F-801/N8008, F-501/N2020 or F-401s/N4004s)	64-65
NON-TTL AUTO FLASH—	
For Shooting with Varied Lens Apertures	66-68
EXPOSURE COMPENSATION IN NON-TTL	
AUTO FLASH MODE	68
USABLE APERTURES/SHOOTING DISTANCE RANGE	
IN TTL AND NON-TTL AUTO FLASH MODES	69
MANUAL FLASH—You Make All The Decisions	70-76
SYNCHRONIZATION IN CONTINUOUS SHOOTING	73
MANUAL FILL-FLASH	74-76
REPEATING FLASH—For Multiple Exposure	77-80
GUIDE NUMBER	81
DIFFUSING LIGHT	82-85
BOUNCE FLASH PHOTOGRAPHY PROCEDURE	83-85
USING A DIFFUSER	85
MULTIPLE FLASH PHOTOGRAPHY	86-91
TTL MULTIPLE FLASH PHOTOGRAPHY	87
SYSTEM CHART FOR TTL MULTIPLE FLASH	88-89
ACCESSORIES FOR TTL MULTIPLE FLASH	90
TTL Remote Cord SC-17	90
TTL Remote Cord SC-24	90
TTL Multi-Flash Adapter AS-10	90
TTL Multi-Flash Sync Cords SC-18 and SC-19	90
MANUAL MULTIPLE FLASH PHOTOGRAPHY	91
CLOSE-UP FLASH PHOTOGRAPHY IN	
TTL AUTO FLASH MODE	92
TIPS ON SPEEDLIGHT CARE	93-94
ABOUT BATTERIES	95
GLOSSARY	96-97
SPECIFICATIONS	98-99

FOREWORD

Thank you for purchasing the Nikon Autofocus Speedlight SB-24. Used together with Nikon's newest SLR models (F4, F-801/N8008, F-401s/N4004s), it offers you the most advanced and complete system for automatic flash photography available. Used with any earlier Nikon SLR model, it lets you take advantage of TTL auto control and creative features such as Strobe-effect multiple flash exposures, and more.

To get the maximum performance from your new SB-24, be sure to take time to read the instruction manual completely. It includes a great deal of important information, including explanations on how to use the newest, most advanced features. Even the most experienced photographers should thoroughly read this manual. Although the SB-24 controls may seem familiar, much of its operation is different from ordinary flash units.

We know you're anxious to get started, so if you are in a real hurry, read the separate "QUICK AUTOMATIC OPERATION WITH THE NIKON F4 OR F-801/N8008." This explains what you need to know to use the SB-24 and the newest Nikon SLRs in the most automatic mode. You'll be surprised how easy that portion is, and you'll get balanced fill-flash pictures, as easy as point-and-shoot.

Then, to learn about all the SB-24's other great features, take time to read the complete manual. Your reward will be better flash pictures, with more variety than you ever imagined possible, and all done easily.

One additional point. Throughout the manual you will see technical terms or photo expressions with which you may not be familiar. To help you learn these terms, we've included a *Glossary*. So if you come upon an unfamiliar term, check the glossary on pages 96 ~ 97.

The Nikon N8008 and N4004s are sold exclusively in the U.S.A. The Nikon N2020 and N2000 are sold exclusively in the U.S.A. and Canada.

www.butkus.us

Do not fire flash near the eyes; doing so may injure the retina. Do not touch the flash head when firing the SB-24; it may be hot due to normal operation. Also, be sure to keep plastics and other delicate materials away from the flash head when hot.

Nikon cannot be responsible for malfunctions or other problems resulting from the use of other manufacturers' flash units, cameras or accessories, including external power sources.

In certain cases, due to normal characteristics of the built-in microcomputer, the speedlight may not operate or an abnormal display may appear, even with fresh, properly installed batteries. If such a case occurs, turn off the flash and remove the batteries, then reinstall batteries and turn the power on. This should properly reset the computer.

"Red eye" is a common problem in flash photography. Normally, flash pictures are taken when the surrounding light is dim, and under such conditions the subject's eye pupils will be dilated (open very wide). Red-eye effect occurs when light from the camera's flash reflects off the interior of the eye and back into the camera's lens. The wide-open pupil allows much light to enter, and as a result, the center portions of a subject's eyes can appear bright red (white in a black and white picture). It is interesting to note that the intensity of the red-eye effect varies among individuals, and with two people in the same photograph, one may have red-eye and the other may not.

The appearance of red-eye is also based on the angle at which the light flashes on the subject and is reflected back to the camera's lens. If the angle is 2 to 2.5 degrees or narrower, the red-eye will occur. As you move closer to a subject, the angle becomes wider, and the likelihood of red-eye effect decreases. As you move farther from a subject, the angle narrows and the incidence of red-eye increases. When you get very far from a subject, the size of the eye in the picture may become so small that red-eye is not apparent, but when you switch to a lens with a longer focal length, the subject becomes bigger and red-eye may become apparent.

With an angle exceeding 2.5 degrees, red-eye is not likely to occur. For example, with a 35-55mm range lens and when standing about 1.4m (4.5 ft) or closer to the subject, the angle between the flash and lens exceeds 2.5 degrees and red-eye effect will most likely not be visible.

NOMENCLATURE

Flash head

Locks at the front position; tilts up to 90° and down to -7°; rotates 90° to right and 180° to left. For bounce flash photography, see pages 83 to 85.

Autofocus assist illuminator LED

Enables autofocus operation in dim light and total darkness.

Light sensor for non-TTL auto flash operation

In non-TTL auto flash operation, be careful not to cover or otherwise obstruct the sensor.

External power source terminal

Accepts power cord of Nikon DC Unit SD-7.

Battery chamber lid

Slide and lift to open.

Flash head tilting lock release lever

Meter/Feet select lever (inside battery chamber)

Battery chamber

Accepts four 1.5V AA-type penlight batteries, either 1.5V alkaline-manganese or 1.2V NiCd batteries (voltage varies depending on manufacturer; maximum permitted is 1.25V).

Mounting foot

Hot-shoe contacts

Mounting foot locking wheel

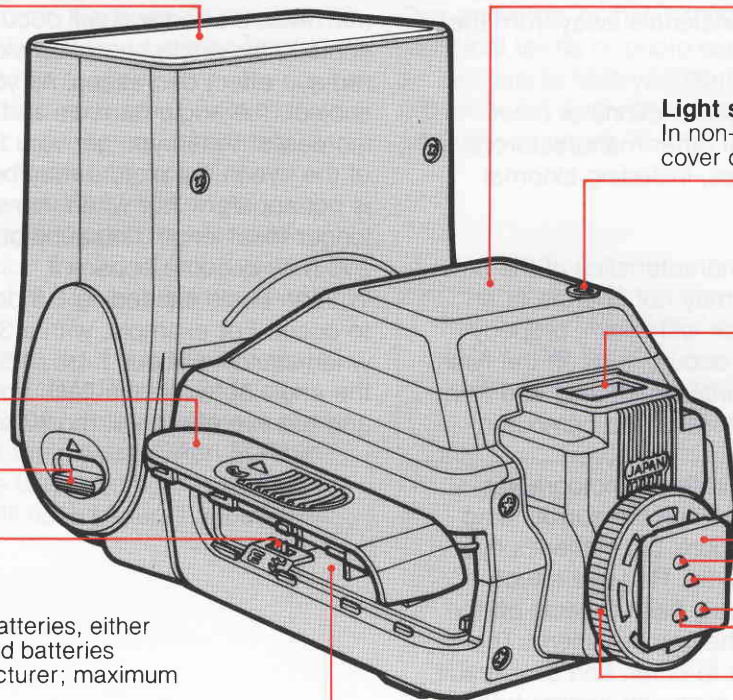

Tilting angle scale

Rotating angle scale

TTL multiple flash terminal

Used for TTL-exposure-control multiple flash operation (see pages 87 to 90).

Sync/multiple flash terminal

Used for manual-exposure multiple flash operation (see page 91).

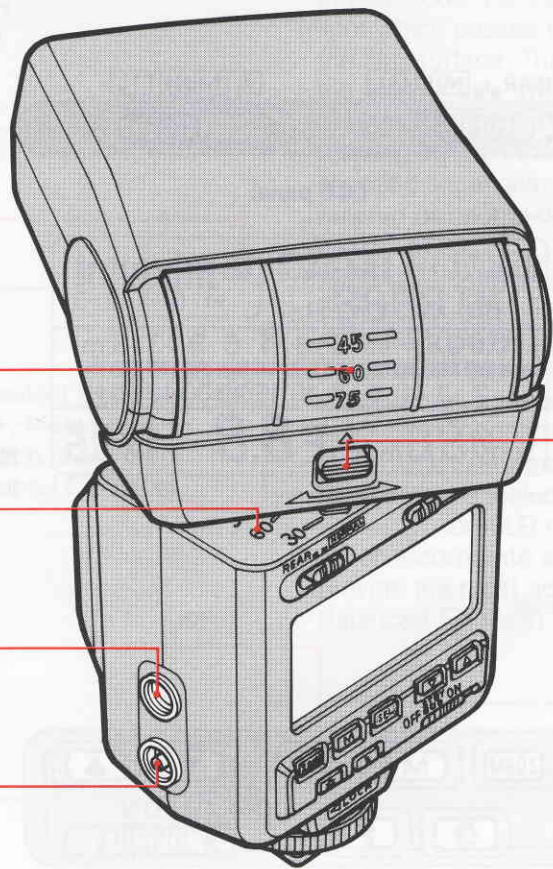

Flash head rotating lock release lever

Flash sync mode selector (see page 11)
NORMAL for front-curtain sync flash
REAR for rear-curtain sync flash



Flash mode selector (see pages 9 to 11)
TTL for TTL auto flash exposure control
A for non-TTL auto flash exposure control
M for manual flash exposure control
555 for repeating flash

Flash mode indicator

LCD panel

Exposure compensation indicator

Film speed/Repeating flash indicator

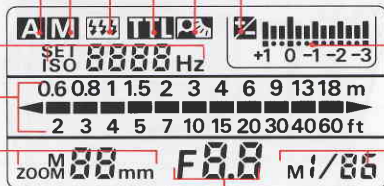

Exposure compensation scale

Flash shooting distance scale

Angle of coverage indicator

Light amount indicator

Aperture indicator

Note: Some marks on the LCD panel may blink; in this manual, blinking is indicated by

M button

In TTL auto mode with F4 or F-801/N8008:
 Push to cancel/activate automatic flash output level compensation.

In manual/repeating-flash mode
 Push to manually select flash output power.

Select button

Controls use (on/off) of adjustment buttons.

Zoom button

Push to manually set zoom head focal length position.

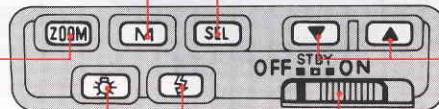

Adjustment buttons (▲ and ▼)

For adjusting flash output level, aperture value, number of flashes, frequency, etc.

Illuminator button

Push to illuminate the LCD panel.

Power switch
 See page 14.

Ready-light/open-flash button

For ready-light indication, see pages 12 to 13.

USABLE FLASH MODES WITH YOUR CAMERA

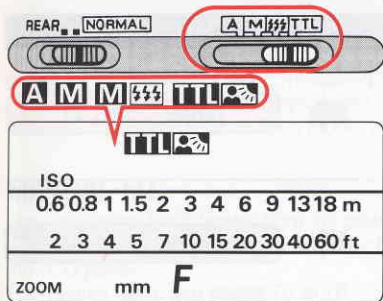

The SB-24's flash mode selector lets you select from four flash modes—TTL Auto **TTL**, Non-TTL Auto **A**, Manual **M** or Repeating-Flash **M**. When the power switch is on, the flash mode indicator confirms your selection in the LCD panel.

TTL AUTO **TTL**





In this mode, the camera's TTL flash sensor measures all the light which passes through the camera's lens and reflects off the film surface. This includes both ambient light and light from the SB-24 flash. The flash shuts off at the moment the sensor detects the correct exposure. Because the sensor detects light passing through the lens, it automatically adjusts for most flash shooting situations, including bounce flash, diffusion filters and colored or neutral-density filters used on the lens or on the flash head.

The SB-24's automatic flash operation depends on the Nikon SLR model used. The chart on the following page indicates the automatic modes available for each SLR model shown.

Subsequent sections of this instruction manual explain each of the different automatic modes.

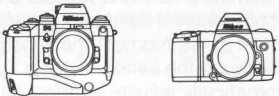
Available flash features also vary depending upon the type of Nikon lens used and camera on which it is used. The newest AF Nikkor lenses include built-in computers, and used with the newest Nikon SLR models (F4, F-801/N8008, F-401s/N4004s)—which incorporate a computer and multi-segment light meter—provide the most advanced flash operation, known as Matrix Balanced Fill-Flash.

USABLE TTL FLASH MODES

Nikon camera	Usable TTL flash	Described on
 F4 F-801/N8008	Matrix Balanced Fill-Flash/Center-Weighted Fill-Flash/Standard TTL Auto	→ pages 25 to 49
 F-401s/N4004s	Automatic Balanced Fill-Flash (with AF Nikkor lenses/Standard TTL Auto including Programmed TTL Auto	→ pages 50 to 56
 F-501/N2020 F-301/N2000	Standard TTL Auto including Programmed TTL Auto (with AI-S-type lenses)	→ pages 57 to 63
 FA FE2	Standard TTL Auto (all shutter speed settings except M250 or B)	→ pages 60 to 63
 FG	Standard TTL Auto (all shutter speed settings except M90 or B)	→ pages 60 to 63

TTL flash control with the SB-24 functions only with selected Nikon SLR models. F3 series, FM2 and FG-20 do not function with the SB-24 and TTL operation. All other flash exposure modes (A M B) function with these SLR models.

FLASH SYNC MODE SELECTOR

NON-TTL AUTO

In this mode, light is read through the light sensor on the front of the SB-24, instead of being measured through the lens. Exposure control requires that you manually adjust the lens aperture. For non-TTL auto flash mode, see pages 66 to 68.

MANUAL

Lets you select flash power from full power of 1/16 power and set aperture according to flash-to-subject distance. Indicated on the LCD panel.

For manual flash, see pages 70 to 76.

REPEATING FLASH

This mode lets you flash a subject two or more times consecutively in the same frame. It enables you to select the number of flashes, flash speed (Hz) and power—either 1/8 or 1/16.

For detailed instructions on repeating flash, see pages 77 to 80.

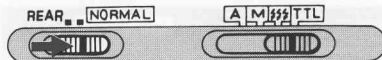

The SB-24 offers two types of flash synchronization, REAR and NORMAL.

NORMAL synchronization, the way virtually all other systems operate, fires the flash at the beginning of the exposure.

REAR synchronization, available with the Nikon F4 or F-801/N8008, fires the flash at the end of the exposure.

For short exposure (speeds up to 1/250 second) you can barely tell the difference between the two methods. For longer exposures, however, when subject movement during the exposure becomes evident, you can clearly see the difference.

Rear synchronization tends to give a more natural effect, making the blur of subject movement appear to emanate from the back for a more comfortable visual effect.

For details, see page 48.

READY-LIGHT INDICATIONS

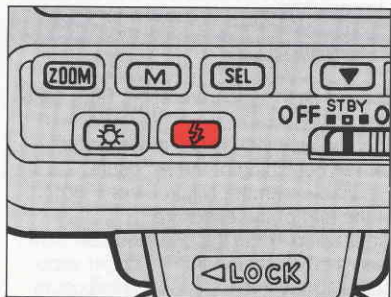

With the SB-24 turned on, its ready-light turns on to indicate the flash is ready to fire. To activate the viewfinder ready-light function when using the Nikon F4, F-801/N8008, F-501/N2020, F-401s/N4004s, F-301/N2000, FA, FE2, or FG, lightly press the shutter release button to turn on the camera's meter.

- If the ready-light takes more than 30 sec. to light up when using alkaline-manganese batteries, replace with a fresh set.
- With NiCd batteries, if recycling time is over 10 seconds, recharge them.

READY-LIGHT WARNING FUNCTIONS

The ready-light in the camera viewfinder blinks in the cases listed below. When blinking occurs, check the SB-24's flash mode selector setting, camera's shutter speed/mode selector setting and/or film speed setting and adjust as necessary.

The ready-light will blink before shooting:

- When SB-24's flash mode selector is at TTL with cameras other than Nikon F4, F-801/N8008, F-501/N2020, F-401s/N4004s, F-301/N2000, FA, FE2, or FG. Reset SB-24's flash mode selector to A or M.
- When using the FA, FE2, or FG to perform TTL auto flash with the camera's shutter speed dial at a mechanical setting (M250, M90 or B). Reset to another shutter speed setting. To use M250, M90 or B, reset SB-24's flash mode selector to A or M.
- When performing programmed TTL auto or TTL auto flash operation with a camera film speed setting beyond the usable range. Use film within the appropriate TTL auto flash photography range (ISO 25 ~ 1000 with F-501/N2020 or F-301/N2000; ISO 25 ~ 400 with F-401s/N4004s, FA, FE2 or FG). With the FA, the ready-light also blinks when the camera's film speed setting approaches ISO 12.
- When the shutter speed of the FE or FM2 is not within the flash sync speed range. Set the shutter speed to the flash sync speed or slower.
- With Nikon F-401s/N4004s, when the SB-24 and built-in flash are turned off, and the camera's computer recommends flash use.

www.borkus.us

After shooting:

With the SB-24 in TTL auto or non-TTL auto flash mode, if both viewfinder ready-light and SB-24 ready-light blink for a few seconds after shooting, the flash has operated at maximum power. Check the SB-24's LCD to determine whether you were standing at a distance beyond the indicated maximum range. Depending on conditions, choose a wider aperture for maximum flash range (switch exposure mode to A or M if it is set at P or S), or move closer to the subject.

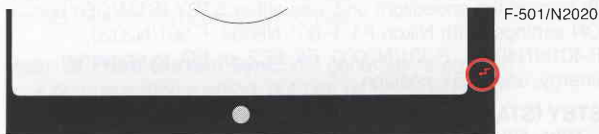
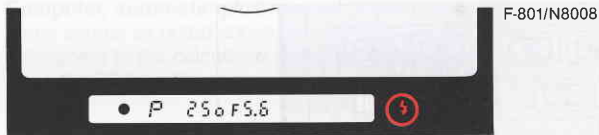
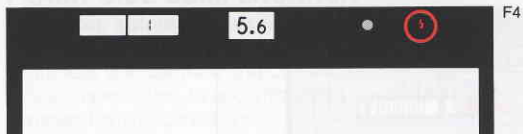

SETTING POWER SWITCH

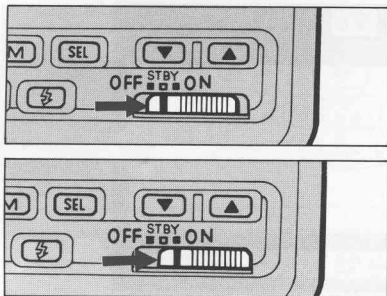

To turn on the speedlight unit, use either STBY (STANDBY) or ON settings. With Nikon F4, F-801/N8008, F-501/N2020, F-401s/N4004s, F-301/N2000, FA, FE2, or FG, to conserve energy, use STBY position.

STBY (STANDBY) Position

---With Nikon F4, F-801/N8008, F-501/N2020, F-401s/N4004s, F-301/N2000, FA, FE2, or FG

In most cases, use STBY position to turn on the SB-24. In STBY position, approx. 80 seconds after the camera's meter turns off, the SB-24 turns off to conserve power. To turn the SB-24 on again, lightly press the camera's shutter release button or the SB-24's open-flash button.

- When using a remote cord with a Nikon FA or FE2 connected to Nikon Motor Drive MD-12, the camera remains on as long as the MD-12's power switch is on. (At STBY position SB-24 does not turn off.)

Special Standby Function

In normal Standby function, when the camera's meter turns off, the SB-24 also turns off. To reactivate the SB-24, turn the camera's meter on. With the following procedure, however, even after the camera's meter turns off, the SB-24 automatically recharges in approx. one-hour intervals, so it will always be ready for long shooting sessions.

1. Set power switch to OFF to turn off the SB-24.
2. While pressing illuminator button, set power switch to STBY.
3. Confirm LCD panel display blinks approx. 8 seconds.

- The SB-24 can be kept in standby for approx. 20 days with AA-type alkaline-manganese batteries or approx. 10 days with AA-type NiCd batteries.
- To cancel this function, set the SB-24's power switch to OFF.

ON Position

---With Nikon FA, FE2 or FG:

To turn on the SB-24 when using a mechanical shutter setting (M250 with FA or FE2, M90 with FG, or B), you cannot use STBY position; set the power switch to ON.

When not using the SB-24, always set power switch to OFF to conserve battery power.

EXPOSURE COMPENSATION

“Correct” exposure is a value based on combinations of film sensitivity, aperture and shutter settings necessary to produce a “technically correct” exposure result. In practical photography, we often want to vary the exposure results to create different versions of the same picture. This is accomplished by using exposure compensation.

Exposure compensation can be accomplished in many ways. The accompanying chart indicates controls that enable compensation with the Nikon SB-24 and the latest Nikon SLR models. In addition to changing the exposure, we can also modify a scene’s lighting by manipulating the light source, thus creating different lighting effects.

Exposure compensation

Flash side (flash exposure)

- Automatic compensation
- Automatic compensation + Manual adjustment
- Manual adjustment

Camera side (available-light exposure)

- Manual control
- Automatic control (Matrix Metering)
- Bracketing
 - Manual
 - Auto (with optional multi-control back)

The following is a brief explanation of the various compensation methods, including those accomplished automatically by the camera/flash computer control, those accomplished through user-controlled operation and alternatives which manipulate the lighting on a scene. As the results can vary depending on individual conditions, you may want to experiment with each method. Experimenting for creativity is what this is all about.

FLASH SIDE COMPENSATION

Computer, automatic: Nikon multi-segment light meters using advanced computer programs evaluate a scene’s brightness and contrast and calculate appropriate exposure compensation to accommodate a wide variety of complex lighting conditions.

Computer, automatic plus manual adjustment: automatic control as noted above, but with a user-determined adjustment to the calculated exposure; accomplished using the SB-24’s EV compensation control.

Manual adjustment: turn off the camera/SB-24 automatic controls and select any manual adjustment using the SB-24’s EV compensation control.

Rear- or Front-Curtain Sync: not generally referred to as a compensation method, but can be considered so because it offers a “different” exposure result.

CAMERA SIDE COMPENSATION

Manual control: adjustment made via the camera's EV compensation control; affects the entire exposure, both available light and light from the flash.

For available compensation range with each film speed, see the table below.

Exposure compensation value	+5	+4	+3	+2	+1	0	-1	-2	-3	-4	-5
Film speed in use											
25											
50											
100											
200											
400											
800/1000											

Automatic control: accomplished via the camera's multi-segment metering system; preprogrammed at the factory according to extensive testing.

Bracketing: results in a variety of different exposures, both under- and overexposed; can be accomplished either by using manual adjustments or by using an optional multi-control accessory back.

LIGHTING MANIPULATION

Bounce flash: can be considered a compensation method since it offers variation to the exposure and augments available light; light may be bounced off various surfaces to create different results.

Multiple flash: using more than one flash to create specific lighting patterns on the subject. May be used either *with* available light, or to obscure (overpower) the effects of available light.

Diffusers: devices placed in front of a camera lens to soften a lighting effect or placed over each flash unit to modify the quality of the light source.

Indirect flash: removing the flash from the camera and holding it to the side, above or from below the subject to create distinctly different lighting effects. This requires a special extension cord which allows you to maintain automatic control.

SETTING BEFORE SHOOTING

INSTALLING BATTERIES

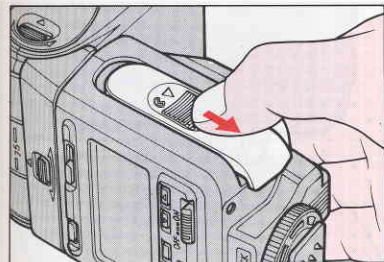

1. Slide the battery chamber cover in the direction of the ▼ and lift to open.

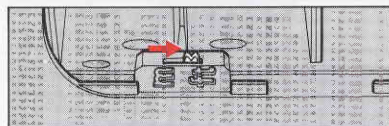
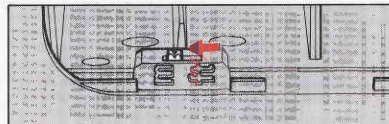

2. Slide the meter/feet lever to select the desired indication (meters or feet) on the LCD panel. (Set at meters when shipped from factory.)

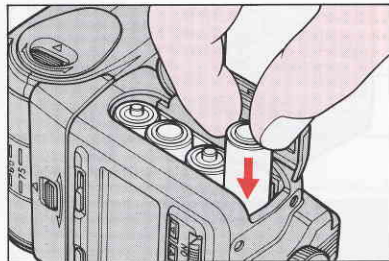

3. Load four 1.5V AA-type penlight alkaline-manganese or 1.2V NiCd batteries into the battery chamber. Be sure to follow the  indicators inside the chamber to ensure batteries are properly loaded.

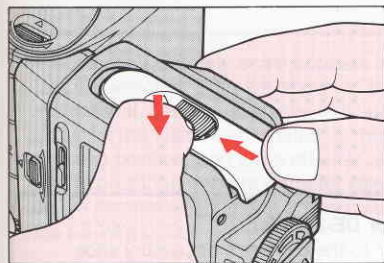

4. Close the battery chamber lid, then slide cover back to close.

For an external power source, use optional Nikon DC Unit SD-7. For battery information, see page 95.

ATTACHING FLASH UNIT TO CAMERA ACCESSORY SHOE

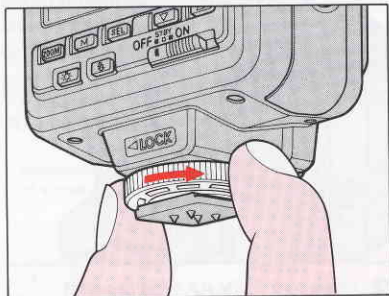

5. Using gentle finger pressure, turn the mounting foot locking wheel clockwise as far as it goes without forcing.

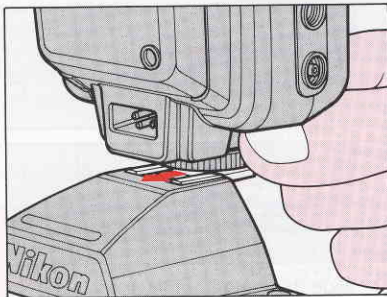

6. Holding the flash near the bottom, slide the mounting foot forward into the camera's accessory shoe as far as it goes.

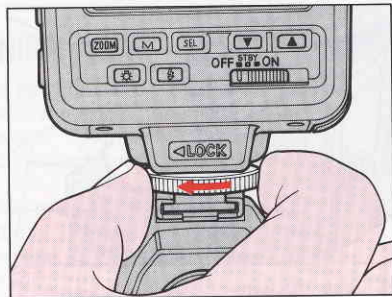

7. Using finger pressure only, gently but firmly tighten the locking wheel.

For Nikon F3-series camera with DE-2 or DE-3 finder:

Attach the Flash Unit Coupler AS-4 or AS-7 to the camera's accessory shoe before mounting the SB-24. The SB-24 cannot be mounted on an F3-series camera with other finders.

www.butkus.us

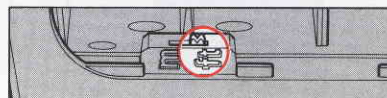
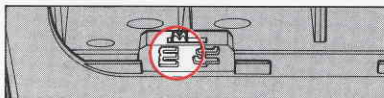
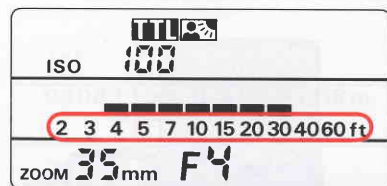
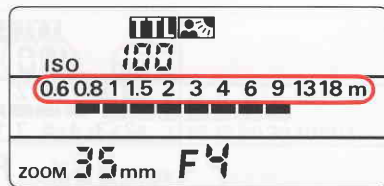
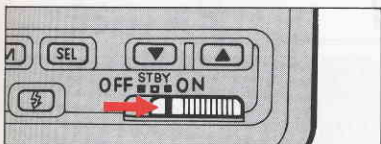
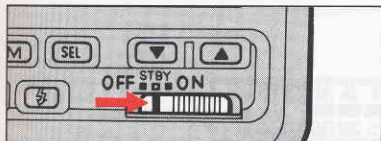

8. Set power switch to STBY (standby position) or ON to turn on SB-24. LCD panel appears. (For details about power switch setting, see page 14).

The shooting distance scale appears in either meters or feet, as selected. Both are shown in the illustrations in this manual. Shooting distance indicator bars do not appear if the flash head is tilted or rotated from normal shooting position, and turns off after about 8 seconds. Gently press the camera's shutter release button to turn on the camera's light meter and simultaneously reactivate the SB-24's LCD.

When it is necessary to set the aperture on the LCD panel using adjustment buttons, F blinks.

For example:

- In Non-TTL Auto **A** flash mode (see pages 66 to 68).
- When using lenses without a built-in CPU.
- When using cameras other than the Nikon F4 or F-801/N8008.

ADJUSTING FLASH HEAD

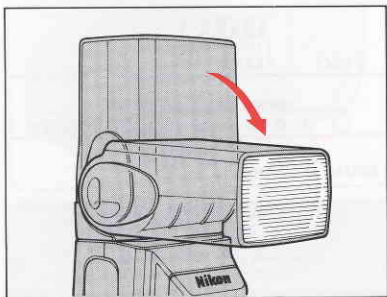

9. Tilt the flash head to normal shooting position, and confirm flash head is locked.

- If flash head is set at -7° , the distance indicator bars blink. Use this position with shooting distances less than 1.5m (approx. 5ft).
- For details on bounce flash photography, see pages 83 to 85.

SETTING ISO FILM SPEED

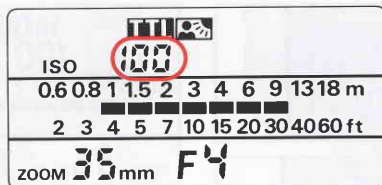

10. Set the ISO film speed.

With F4, F-801/N8008 or F-401s/N4004s: Turn on the camera and lightly press the shutter release button. The film speed will be indicated on the LCD panel.

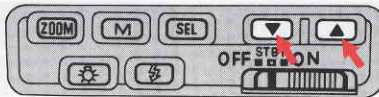
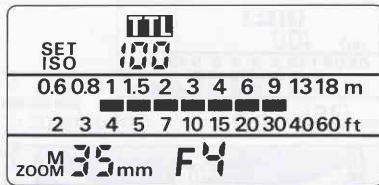
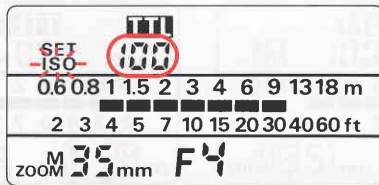
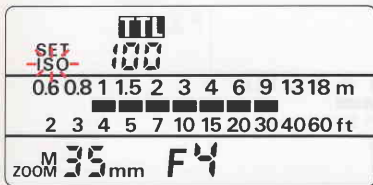

With other cameras:

- (1) Push select button so "ISO" starts blinking in the LCD panel.
- (2) While "ISO" is blinking, press the adjustment button ▼ or ▲ to set the film speed in use.
 - If you do not press the adjustment button for approx. 8 seconds or more, "ISO" automatically stops blinking. To reactivate "ISO," press the select button again.
- (3) When the desired film speed appears, press select button again to cancel blinking.
 - If "ISO" stops blinking automatically, you do not need to press the select button again.

Except in Non-TTL Auto flash mode, the film speed is essentially just a number displayed in the LCD panel. This means that, even if the displayed ISO number is incorrect, as long as all other camera and speedlight settings are correct, the subject will be correctly exposed. Therefore, the ISO setting cannot be used as an exposure compensation control. A separate exposure compensation control provides that opportunity.

SETTING ANGLE OF COVERAGE

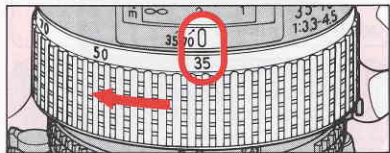

11. Set the zoom head.

When using the F4 or F-801/N8008 with an AF Nikkor or Nikkor lens having a built-in CPU:

Within a covering power of 24mm to 85mm, the zoom head automatically adjusts to provide an angle of coverage that matches the focal length of the lens in use (indicated in the LCD panel). When used in automatic selection mode with AF Nikkor lenses of fixed focal length, the SB-24 zoom head automatically adjusts to the closest available wider focal length setting. With zoom lenses, the zoom head automatically adjusts as the zoom lens adjusts, within the limits of the available zoom coverage of the SB-24.

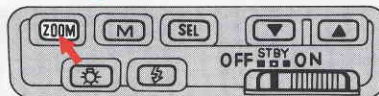
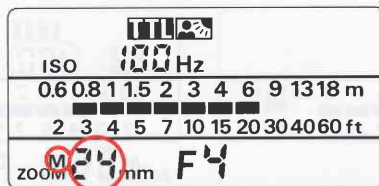

It is also possible to select your desired angle of coverage manually, by pressing the zoom button [ZOOM]. In the LCD panel, "M" appears above "ZOOM" indicator.

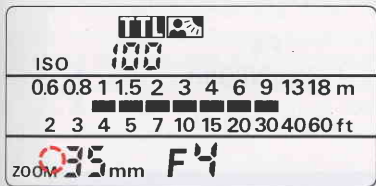

To return to auto position, repeatedly press the button until the "M" above "ZOOM" disappears (next setting after M85mm).

For focal lengths wider than 24mm, slight vignetting will occur. Consider bounce flash or use of a diffuser card to achieve expanded coverage. For focal lengths longer than 85mm, the flash will provide over-coverage.

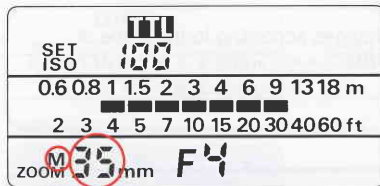
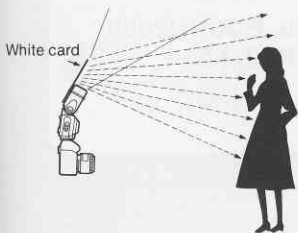

For other camera/lens combinations

Press the zoom button below the LCD panel until the figure in the panel shows the focal length of the lens in use or shorter. The figure changes as follows: -24mm-28mm-35mm-50mm-70mm-85mm-

For zoom lenses other than AF Zoom Nikkor, to cover the full focal length range, select the zoom position that covers the shortest focal length of the lens (e.g., with an AF28-85mm f/3.5-4.5 lens, select 28mm). "M" appears above "ZOOM" indicator when the zoom head is set manually.

SETTING ANGLE OF COVERAGE

The guide number changes according to the angle of coverage. See page 81.

If the shooting distance is less than 1.5m (approx. 5ft), or for close-up photography when SB-24 is separate from the camera body, select the zoom position that is shorter than the focal length of the lens in use. To help ensure full flash coverage, be sure to aim the flash properly.

F4
F-801/N8008

pages 25 to 49

F-401s/N4004s

pages 50 to 56

F-501/N2020, F-301/N2000,
FA, FE2, FG

pages 57 to 63

TTL AUTO FLASH WITH NIKON F4 OR F-801/N8008



The SB-24 takes full advantage of the F4 and F-801/N8008's built-in computer, which automatically synchronizes the camera's shutter speed and lens aperture to provide precisely controlled exposures. The capability to handle wider brightness ranges and use fill-flash under more complex conditions varies from automatic operation to more advanced user-controlled options.

With the Nikon F4 or F-801/N8008, by setting the SB-24 to TTL auto flash mode, you will achieve advanced yet simplified fill-flash photography.

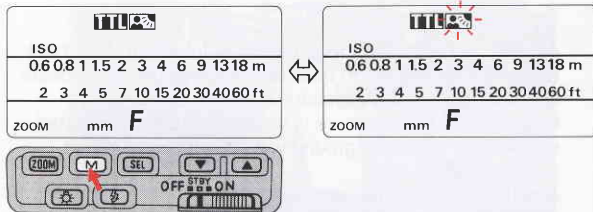
You can choose any of the following flash categories—Matrix Balanced Fill-Flash, Center-Weighted Fill-Flash or standard TTL flash, according to the SB-24's TTL mode (with or without automatic flash output level compensation) and camera's metering system (Matrix or Center-Weighted).



To cancel/activate automatic flash output level compensation, (to select either  or ), use the SB-24's "M" button.

SB-24	With automatic flash output level compensation	Without automatic flash output level compensation
Camera metering system		
Matrix Metering	Matrix Balanced Fill-Flash	Standard TTL flash
Center-Weighted Metering	Center-Weighted Fill-Flash	

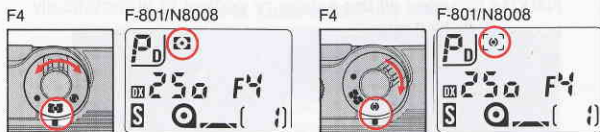

To select either Matrix Metering or Center-Weighted Metering, use the F-801/N8008's metering system selection button, or for the F4, selection dial.

- When the F4 is set for Spot Metering, only standard TTL flash is available and will be selected automatically.
- The SB-24 takes full advantage of a special photographic technique called rear-curtain sync flash. For details see page 48.

FILL-FLASH PHOTOGRAPHY

A backlit subject, such as a person outside with their back to the sun, or indoors in front of a window, usually appears as a silhouette if the exposure is set for background brightness. If the exposure is set for a darker, silhouetted subject, then the background will be overexposed and appear washed out.

A better result can be achieved by leaving the exposure set for the brighter background and then using the flash to illuminate the darker foreground subject. This brings the brightness of the foreground subject up to the brightness of the background. This technique is called "fill-flash", and the SB-24 together with a Nikon F4, F-801/N8008 or F-401s/N4004s provides all the exposure control to automatically accomplish fill-flash.



With flash



Without flash



Exposure compensated

www.butkus.us

The SB-24 is capable of several different automatic fill-flash methods. The method you choose depends on the Nikon SLR model you use, lighting conditions, subject movement and the esthetic qualities you wish to achieve. Carefully consider each picture situation.

MATRIX BALANCED FILL-FLASH

This is a feature of Nikon SLR models having multi-segment light meters (Matrix meter). The camera's Matrix meter reads the scene's light levels and light patterns, and signals the computer, which then calculates the available-light exposure settings. When the shutter is released, the camera's TTL sensor senses available light and flash illumination, then relays the information to the computer, which automatically controls the flash operation. The computer automatically determines the appropriate amount of flash exposure compensation to use. When the computer senses just the right amount of flash illumination for a balanced fill-flash exposure (based on the automatic compensation control), the flash is turned off. The result is a well-balanced photo with the correct exposure for both background and foreground subjects. All this takes place automatically and much quicker than it can be explained.



Matrix Balanced Fill-Flash



Standard TTL Flash

CENTER-WEIGHTED FILL-FLASH

While the Matrix meter can automatically measure up to five different segments of the scene's brightness, the Center-Weighted meter measures the entire scene and emphasizes its reading on the center area. By pointing the center-weighted area at different parts of the picture, you can choose which brightness level you want for the basic available-light exposure, as compared to the Matrix system which uses computer evaluation to determine the brightness/contrast levels upon which exposure will be based.

If the brightness value you have selected is within the controlled shutter/aperture range possible, the flash output compensation will be automatically set for a natural fill-flash effect. The amount of computer selected automatic compensation available varies with each Nikon SLR model. For details, check your camera instruction manual. If you select a brightness value beyond the controlled shutter/aperture range, the flash output will be set without compensation, as with standard TTL flash operation.

STANDARD TTL FLASH

This mode may be used with either the Matrix Meter or Center-Weighted Meter. It differs from balanced fill-flash operation by allowing you to manually select the amount of flash compensation instead of having the computer select it automatically. You select the amount of compensation, from EV +1 to EV -3, using the SB-24's EV compensation scale.

Both Matrix and Center-Weighted modes always incorporate some form of computer compensation, even if you make adjustments manually. In Standard TTL mode, only your manually selected compensation amount is used.

For manual flash output compensation, see pages 46 to

47.

www.butkus.us

USABLE TTL AUTO FLASH ACCORDING TO LENS/EXPOSURE MODE/METERING SYSTEM COMBINATION

With F4

Lenses		Viewfinder Exposure mode Metering system	Multi-Meter Finder DP-20				AE Action Finder DA-20				Waist-Level Finder DW-20/ 6X High-Magnification Finder DW-21			
			P _{PH}	S	A	M	P _{PH}	S	A	M	P _{PH}	S	A	M
AF Nikkor lenses AI-P-type Nikkor lenses	Matrix	⊙	⊙	⊙	⊙	—	—	—	—	—	—	—	—	
	Center-Weighted	○	○	○	○	○	○	○	○	—	—	—	—	
	Spot	△	△	△	△	△	△	△	△	△	△	△	△	
AF Teleconverter/AF Nikkor lenses for Nikon F3AF/ AI-type Nikkor lenses (including AI-S)	Matrix	⊙*	⊙*	⊙	⊙	—	—	—	—	—	—	—	—	
	Center-Weighted	○*	○*	○	○	○*	○*	○	○	—	—	—	—	
	Spot	△	△	△	△	△	△	△	△	△	△	△	△	
Other lenses	Matrix	△	△	△	△	—	—	—	—	—	—	—	—	
	Center-Weighted	△	△	△	△	△	△	△	△	—	—	—	—	
	Spot	△	△	△	△	△	△	△	△	△	△	△	△	

⊙ Matrix Balanced Fill-Flash

○ Center-Weighted Fill-Flash

△ Standard TTL flash

* Exposure mode automatically shifts to A. Select aperture manually.

• TTL Remote Cord SC-24 is required when using DW-20 or DW-21.

With F-801/N8008

Lenses		Exposure mode Metering system	P _D	S	A	M
			P _{PH}			
AF Nikkor lenses/ AI-P-type Nikkor lenses	Matrix	⊙	⊙	⊙	⊙	
	Center-Weighted	○	○	○	○	
Other lenses**	Matrix	○*	○*	○	○	
	Center-Weighted	○*	○*	○	○	

⊙ Matrix Balanced Fill-Flash

○ Center-Weighted Fill-Flash

△ Standard TTL flash

* Exposure mode automatically shifts to A. Select aperture manually.

** Includes AF Teleconverters, AI-type Nikkor lenses (including AI-S), Bellows Focusing Attachment PB-6, Auto Extension Rings, etc.

MATRIX BALANCED FILL-FLASH OPERATION

For Matrix Balanced Fill-Flash, first make sure of the following:

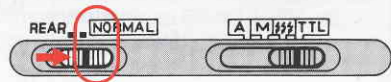
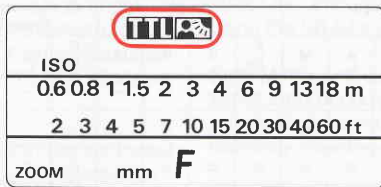
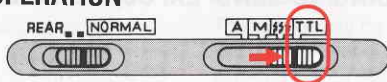

* Set the SB-24's mode selector to TTL, and confirm  mark stays on.

* Choose and set the flash sync mode selector to NORMAL.

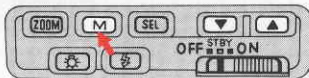

If  mark is blinking, push the SB-24's "M" button.

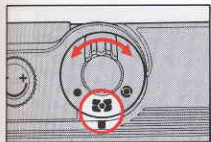

F4

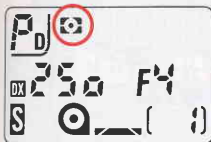

F-801/N8008

* Set the metering system on the camera to Matrix Metering.

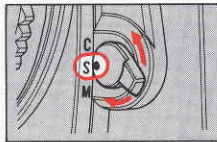

F4

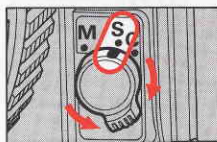

F-801/N8008

* For autofocus operation, choose and set the camera's focus mode to Single Servo Autofocus. (For details about autofocus flash photography, see pages 64 to 65.)

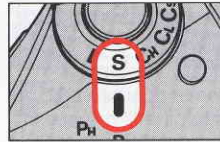

F4

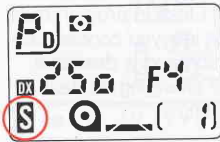

F-801/N8008

* Choose and set the camera's film advance mode to single-frame shooting.

- The usable film speed for TTL flash photography is ISO 25-1000.

For Center-Weighted Fill-Flash Operation

Follow the procedure for Matrix Balanced Fill-Flash, but set the camera to Center-Weighted exposure metering instead.

In Programmed Auto Exposure Mode

This mode automatically selects the optimum combination of aperture and shutter speed to match the film speed in use and the brightness of the scene.

Matrix Balanced Fill-Flash in programmed auto exposure mode lets you concentrate on picture composition and is desirable when conditions are changing too fast for you to pause for settings.

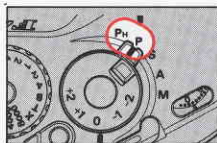

F4

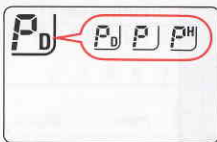

F-801/N8008

1. Set the F4 or F-801/N8008 camera's exposure mode selector to P, PH or PD*.

*For F-801/N8008 only.

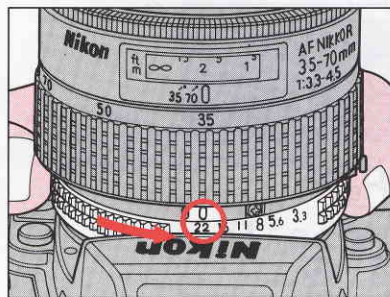

2. Set lens to minimum aperture (i.e. highest f-number). If not properly set, the shutter locks. (F4 shutter displays FEE, but will fire.)

In programmed auto and shutter-priority auto exposure mode, you cannot use a non-CPU lens. With a non-CPU lens in aperture-priority auto exposure mode, set the camera's exposure mode to A.

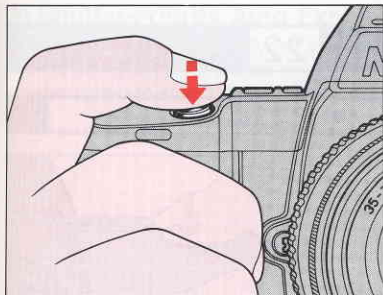

3. Look into the viewfinder, compose and lightly press the shutter release button.

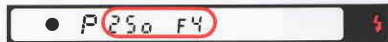
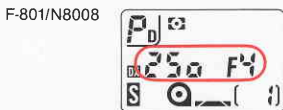

Confirm the controlled aperture and a shutter speed between 1/60 sec. and 1/250 sec. appear in the camera's viewfinder. The aperture-in-use and shooting distance indicator bars appear in the SB-24's LCD panel.

With the F-801/N8008, the controlled aperture and shutter speed also appear on the camera's LCD panel.

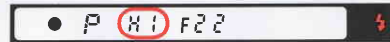
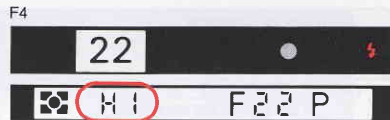

Overexposure warning

For overexposure alert, HI appears (together with lens' minimum aperture for the F-801/N8008) in the position indicating the camera's shutter speed.

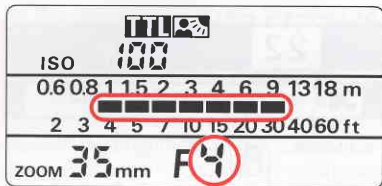

Confirm the shooting distance range in the SB-24's LCD panel. The shooting distance range is automatically indicated by the distance indicator bars.

- *When you remove your eyes from the camera to confirm the information on the SB-24's LCD panel, the camera may move slightly and cause the exposure value to change. To prevent this, use the AEL (Auto Exposure Lock) button.*

Shooting distance range changes according to aperture value, film speeds, zoom setting and/or flash level compensation selected on the camera or SB-24. For shooting distance range, see page 69.

www.butkus.us

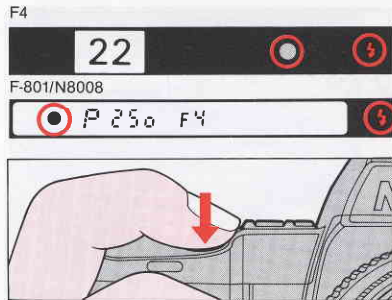

4. Confirm the ready-light and in-focus indicator are on, then fully depress the shutter release button to take the picture.
 - *For blinking ready-light warning, see pages 12 to 13.*

In Shutter-Priority Auto Exposure Mode

This mode lets you manually set your desired shutter speed and the matching aperture will be selected automatically. Use a fast shutter speed to stop action, a slow one to produce a deliberate blur.

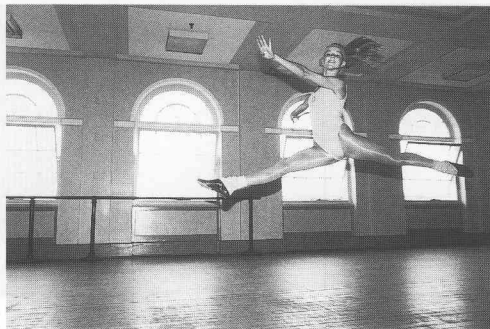

1/250 sec.



1/30 sec.

In programmed auto exposure mode and shutter-priority auto exposure mode, non-CPU lenses cannot be used. For aperture-priority auto exposure mode with a non-CPU lens, set the camera's exposure mode to A.

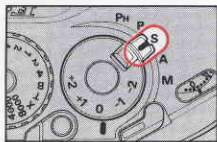

F4

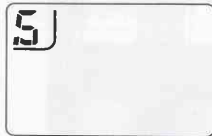

F-801/N8008

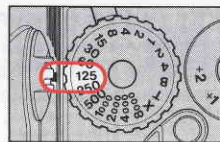
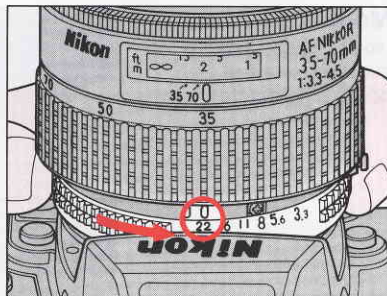

F4

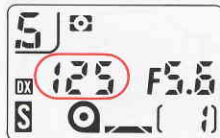

F-801/N8008

1. Set the F4 or F-801/N8008 camera's exposure mode selector to S.

2. Set lens to minimum aperture (highest f-number). If not properly set, the shutter locks. (F4 shutter displays FEE, but will fire.)

3. Set your desired shutter speed on the camera.

- If you select a shutter speed faster than 1/250 sec. and turn the flash unit on, the camera automatically shifts to 1/250 sec.

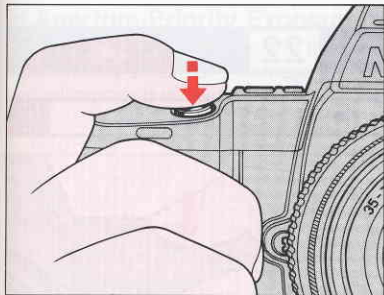

4. Look into the viewfinder, compose the shot and lightly press the shutter release button.

F4



F-801/N8008

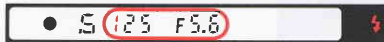
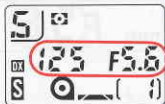

Check the exposure.

With F4 camera:

Check camera's viewfinder to confirm the selected shutter speed is between 4 sec. and 1/250 sec., (or X) and the aperture is controlled. The aperture-in-use and shooting distance indicator bars appear in the SB-24's LCD panel.

With F-801/N8008 camera:

Check the camera's viewfinder or LCD panel to confirm the selected shutter speed is between 30 sec. and 1/250 sec. and the aperture is controlled between f/2.8 and the lens' minimum aperture. The aperture-in-use and shooting distance indicator bars appear in the SB-24's viewfinder.

F4

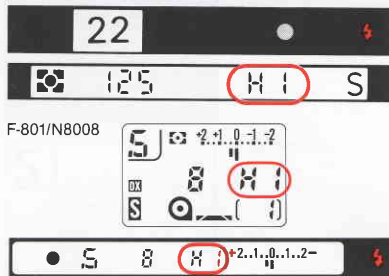

F-801/N8008

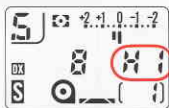

Overexposure warning

For overexposure alert, HI appears in the position indicating the camera's aperture.

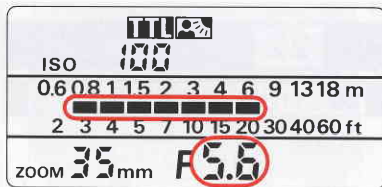

Confirm the shooting distance range in the SB-24's LCD panel. The shooting distance range is automatically indicated by the distance indicator bars.

F4

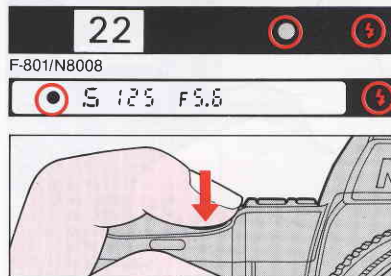

F-801/N8008

5. Confirm the ready-light and in-focus indicator are on, then fully depress shutter release button to take the picture.

• For *blinking ready-light warning*, see pages 12-13.

Shooting distance range changes according to aperture value, film speeds, zoom setting and/or flash level compensation selected on the camera or SB-24. For shooting distance range, see page 69.

www.butkus.us

In Aperture-Priority Exposure Mode

You select the lens aperture and the matching shutter speed is automatically selected. This mode is recommended for controlling depth of field.



f/2.8

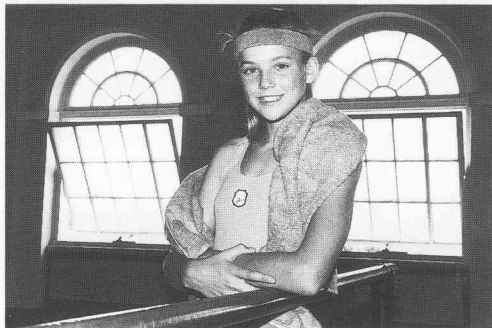

f/5.6

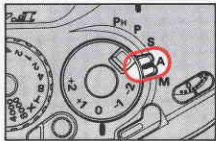

F4



F-801/N8008

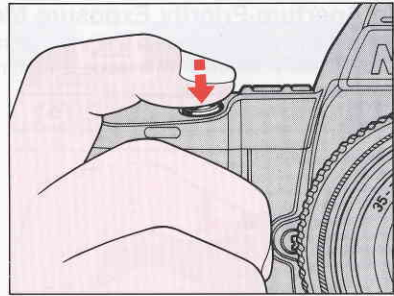
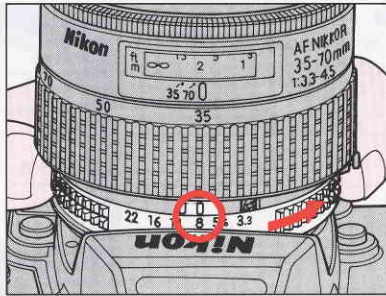

1. Set the F4 or F-801/N8008 camera's exposure mode selector to A

2. Set your desired aperture on the lens.

3. Look into the viewfinder, compose and lightly press shutter release button.



www.butkus.us

F4

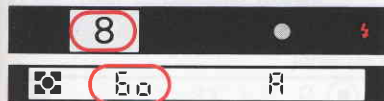

F-801/N8008

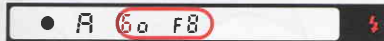
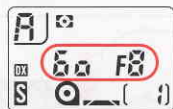

Check the exposure.

Check the camera's viewfinder to confirm the selected aperture and a controlled shutter speed between 1/60 and 1/250 sec. appear. The aperture-in-use and shooting distance indicator bars appear in the SB-24's LCD panel.

With the F-801/N8008 camera, the selected aperture and controlled shutter speed also appear on the camera's LCD panel.

F4



F-801/N8008

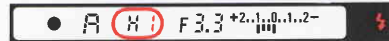

Overexposure warning:

For overexposure alert, HI appears in the position indicating the camera's shutter speed. Select a smaller aperture.

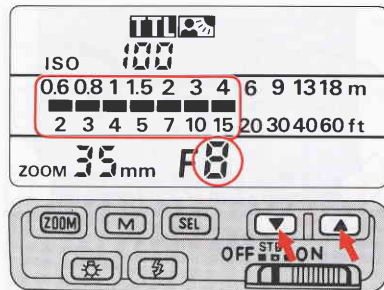
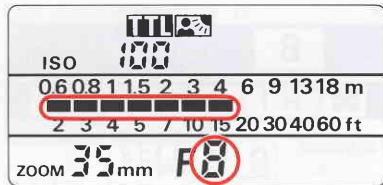

Confirm the shooting distance range in the SB-24's LCD panel.

With an AF Nikkor or Nikkor lens w/built-in CPU:

The shooting distance range is automatically indicated by the distance indicator bars.

With other lenses:

Press the adjustment button to set the aperture to your selected lens aperture.

For example: With the zoom setting at 35mm and the film speed index at ISO 100, selecting f/8 lets you take pictures of subjects 0.6m to 4m (approx. 2ft. to 15ft.) away

Shooting distance range changes according to aperture value, film speeds, zoom setting and/or flash level compensation selected on the camera or SB-24. For shooting distance range, see page 69.

www.butkus.us

F4

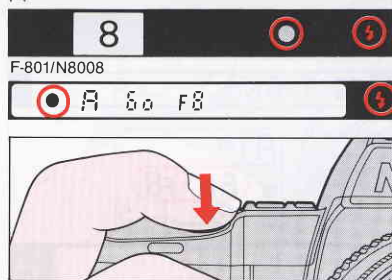

4. Confirm the ready-light and in-focus indicator are on, then fully depress shutter release button to take the picture.

- For blinking ready-light warning, see pages 12 to 13.

In Manual Exposure Mode

In this mode, you set both the shutter speed and aperture manually according to the desired effect.

F4

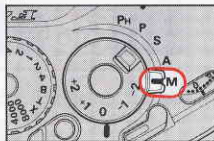

F-801/N8008

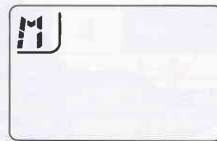

1. Set the F4 or F-801/N8008 camera's exposure mode selector to M.

F4

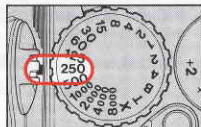

F-801/N8008

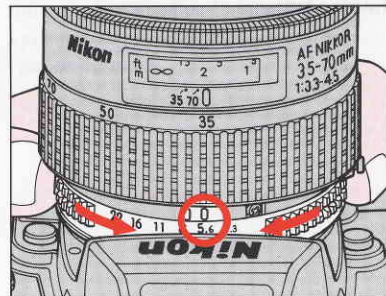
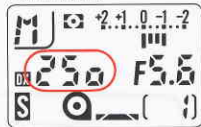

2. Set your desired shutter speed within the sync range and set your desired aperture on the lens.

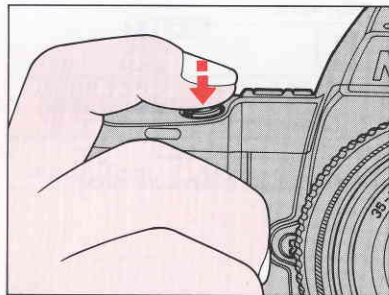

- 3.** Look into the viewfinder, compose the shot and lightly press the shutter release button.

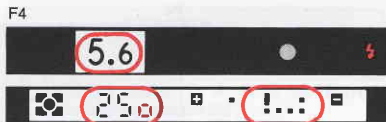

F-801/N8008

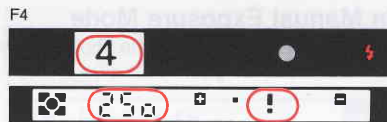
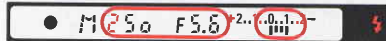
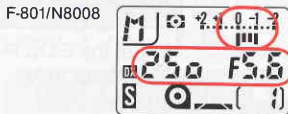

F-801/N8008

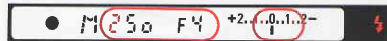
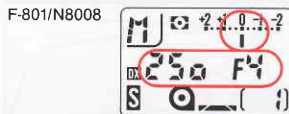

Check the camera's viewfinder to confirm manually selected shutter speed and aperture. The Electronic Analog Display shows the difference in value from the controlled range.

Adjust aperture and/or shutter speed until the Electronic Analog Display indicates 0 or the desired value.

With the F-801/N8008, you can check exposure with the camera's LCD panel.

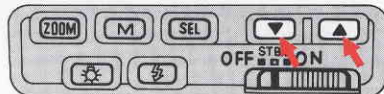
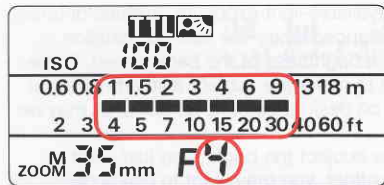
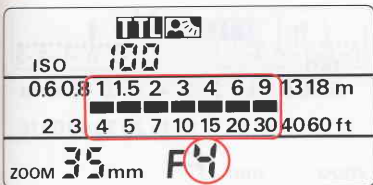

With other lenses:

Press the adjustment button to set aperture to your selected lens aperture. For example: With zoom setting at 35mm and films speed index at ISO 100, selecting f/4 lets you take pictures of subjects 1m to 9m (approx. 4ft. to 30ft.) away.

Confirm the shooting distance range in the SB-24's LCD panel.

With an AF Nikkor or Nikkor lens w/built-in CPU:

The shooting distance range is automatically indicated by the distance indicator bars.

Shooting distance range changes according to aperture value, film speeds, zoom setting and/or flash level compensation selected on the camera or SB-24. For shooting distance range, see page 69.

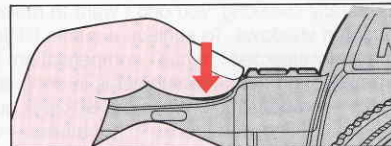
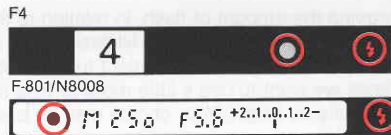

4. Confirm the ready-light and in-focus indicator are on, then fully depress shutter release button to take the picture.

- For blinking ready-light warning, see pages 12 to 13.

FLASH EXPOSURE COMPENSATION

Varying the amount of flash, in relation to the available-light exposure, creates different fill-flash effects. We say the fill-flash effect is balanced when the flash illumination is sufficient to brighten the subject to “almost” the brightness of the background. Sometimes we want to use a little more or less flash to make the subject a little brighter or not quite so bright. Your choice may be based on desired esthetic qualities, or may be forced by extremes in lighting.

Generally speaking, you don’t want to make the subject too bright, you just want to brighten shadows. To achieve a subtle fill-flash effect, you may want to use some manually selected “minus” compensation. However, when the background is extremely bright, and the subject is in deep shadows, you will probably want to use some “plus” compensation. While the SB-24 is quite powerful, whenever using it for fill-flash, it is competing with the sun’s brightness—very strong competition.

With standard TTL flash (with  blinking) you can manually compensate exposure by adjusting flash output level. You can also adjust flash output level for Matrix Balanced Fill-Flash or Center-Weighted Fill-Flash, in combination with the computer’s automatic compensation.

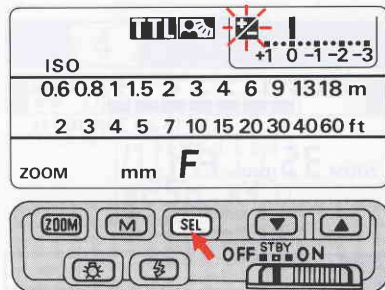

1. Press the SB-24’s select button, and confirm the compensation scale appears and  indicator starts blinking in the LCD panel.

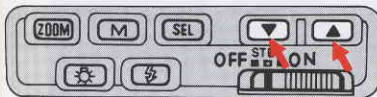
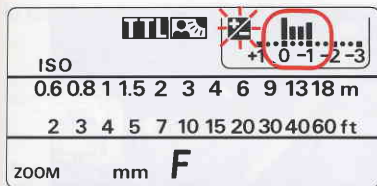

2. While indicator is blinking, press “▼” button to increase the value or “▲” button to decrease it. The shooting distance range changes accordingly.

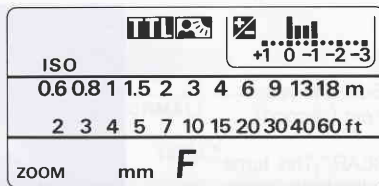

3. Press the select button again, then confirm indicator stops blinking. Setting is complete.

- If you do not press the select button within approx. 8 sec., the indicator also stops blinking.
- The exposure compensation value remains in the LCD panel after setting. (If exposure compensation value is 0, the indication disappears.)

You can make additional compensation by using the camera's exposure compensation dial. For example, with compensation of -2 on the SB-24 and -1 on the camera body, the total compensated value for flash output level is -3, and the compensated value for the background will be -1. Note that the LCD panel shows only the compensated value on the SB-24.

REAR-CURTAIN SYNC FLASH—For Natural Light Flows

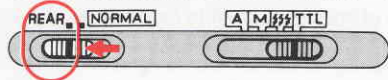

When used with the F4 or F-801/N8008, the SB-24 lets you synchronize the flash to the instant before the rear (second) curtain begins to close.

Set the SB-24's flash sync mode selector to "REAR." This turns available light into a stream of light that follows the flash-illuminated moving subject.

Rear-curtain sync flash photography is most effective with slower shutter speeds. Although the slowest possible shutter speed for front-curtain sync flash photography in TTL mode (with camera at PD, P, PH or A) is only 1/60 second, with rear-curtain sync flash photography, depending on the background, you can slow the shutter down to 30 seconds.

- *In shutter-priority auto or manual exposure mode, be sure to select an appropriate shutter speed. In programmed auto or aperture-priority auto exposure mode, confirm shutter speed is not too slow. Otherwise, it could affect image sharpness. To prevent camera shake, use a tripod.*
- *Rear-curtain sync flash is available when flash mode selector is set to TTL, A or M.*



Rear-curtain sync



Front-curtain sync

SHUTTER SPEED/APERTURE FOR EACH EXPOSURE MODE IN TTL AUTO FLASH

In Matrix Metering (with 50mm f/1.4 lens at ISO 100)



Speedlight Exposure mode	Front-curtain sync (NORMAL)		Rear-curtain sync (REAR)	
PD*/P/PH	1/60-1/250 f/4-f/16 (1)	1/60-1/250 f/4-f/16 (1)	30-1/250 f/4-f/16 (1)	30-1/250 f/4-f/16 (1)
S	As set (3) f/2.8-f/16 (2)	As set (3) f/2.8-f/16 (2)	As set (3) f/2.8-f/16 (2)	As set (3) f/2.8-f/16 (2)
A	1/60-1/250 As set	1/60-1/250 As set	30-1/250 As set	30-1/250 As set
M	As set (3) As set	As set (3) As set	As set (3) As set	As set (3) As set

*F-801/N8008 only.

: Matrix Balanced Fill-Flash (background correctly exposed; TTL flash level automatically compensated)

: Standard TTL flash (background correctly exposed)

- (1) Maximum usable aperture varies according to film speed in use; minimum aperture is the smallest aperture of the lens in use. With the F4, aperture is automatically controlled between the lens' maximum aperture to its minimum.
- (2) Maximum usable aperture is f/2.8; minimum aperture is the smallest aperture of the lens in use. With the F4, aperture is automatically controlled between the lens' maximum aperture to its minimum.
- (3) When set from 1/500 to 1/8000 sec., the shutter is automatically set to 1/250 sec.

TTL AUTO FLASH WITH NIKON F-401s/N4004s

The SB-24's flash light output control is performed in the same manner as the camera's built-in TTL flash. The SB-24's light output amount, however, is more powerful than the camera's built-in TTL flash.

Although the SB-24's shooting distance range is greater than that of the built-in flash, TTL auto flash shooting operation with the SB-24 is same as with the camera's built-in flash.

SHOOTING BRIGHT AND DARK SUBJECTS

Depending on the camera's exposure mode, you can perform Programmed TTL auto flash or TTL auto flash operation. Balanced fill-flash is not possible, however, at brightness levels darker than EV10. The camera's computer automatically detects brightness and chooses the appropriate flash mode.



Note that the camera's viewfinder ready-light LED blinks to indicate you should use a flash only when the optional flash unit attached on the camera is turned off.

- With the F-401s/N4004s camera, for correct exposure in TTL auto flash mode, use film with a speed of ISO 25 to ISO 400.
- With the F-401s/N4004s,  mark will not appear.

www.butkus.us

Programmed TTL Auto Flash— In Program or Shutter-Priority Auto Exposure Mode

Programmed TTL auto flash simplifies operations, because the camera's computer automatically selects both shutter speed and aperture.

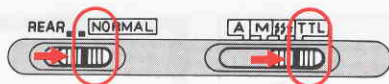

SET ISO	
0.6 0.8 1 1.5 2 3 4 6 9 13 18 m	
2 3 4 5 7 10 15 20 30 40 60 ft	
ZOOM M mm F	

For Programmed TTL auto flash operation, use only AF Nikkor lenses, but not AF Nikkor 80mm f/2.8, 200mm f/3.5 IF-ED or Autofocus Converter TC-16/TC-16A.

1. Set the SB-24's flash mode selector to TTL, and the flash sync mode selector to NORMAL.

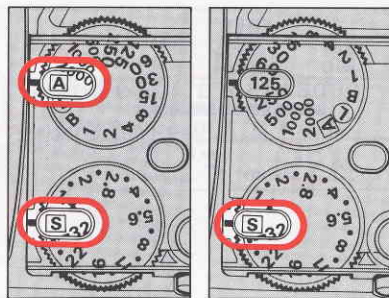

2. Set the camera's exposure mode to either program auto or shutter-priority auto exposure mode.

- For autofocus operation, set the camera's focus mode selector to A. (For details about autofocus flash photography, see pages 64 to 65).

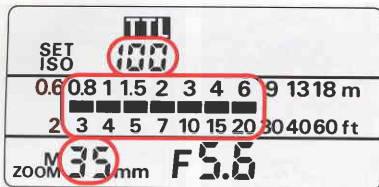

3. Make sure the shooting distance is within the flash range. Refer to the chart for the flash range for each ISO film speed.

Unit: meters (feet)

ISO film speed					Zoom setting					
400	200	100	50	25	24mm	28mm	35mm	50mm	70mm	85mm
11	8	5.6	4	2.8	0.7-5.3 (2.2-17)	0.7-5.6 (2.4-18)	0.8-6.3 (2.7-20)	1.0-7.4 (3.1-24)	1.1-8.3 (2.5-27)	1.1-8.8 (3.7-29)

For example:

With the zoom setting at 35mm and film speed index at ISO 100, you can take pictures of subjects 0.8m to 6.3m (approx. 2.7ft. to 20ft.) away.

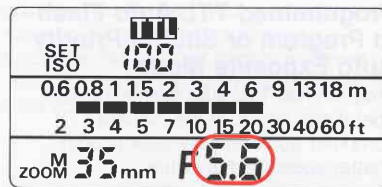

For a convenient reference, use the adjustment buttons to set the aperture (f-number) in the SB-24's LCD panel, as indicated by the chart.

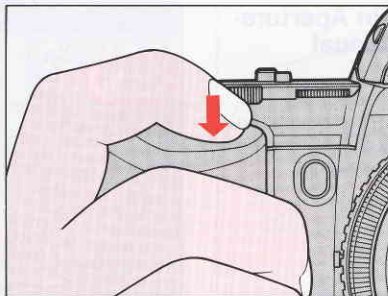
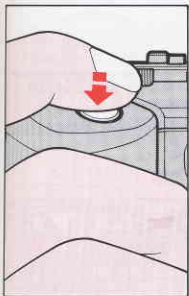

- 4.** Lightly press the shutter release button and confirm the ready-light and in-focus indicator are on.

- 5.** Fully depress shutter release button to take the picture.

• For blinking ready-light warning, see pages 12 to 13.

TTL Auto Flash—In Aperture-Priority Auto or Manual Exposure Mode

TTL Auto Flash lets you select any aperture from $f/1.4$ to $f/32$ to match the shooting distance range with automatic TTL control of the flash exposure.

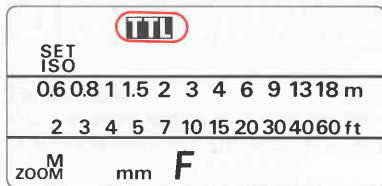
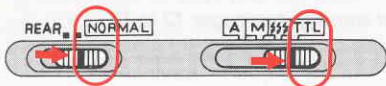

1. Set the SB-24's flash mode selector to TTL, and the flash sync mode selector to NORMAL.

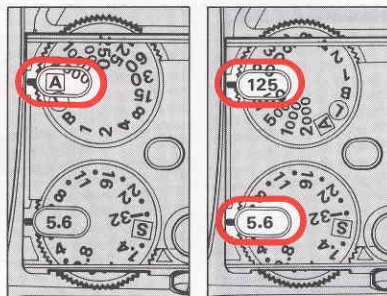

2. Set the camera's exposure mode to either aperture-priority auto or manual exposure mode.

- For autofocus operation, set the camera's focus mode selector to A. (For autofocus flash photography, see pages 64 to 65).

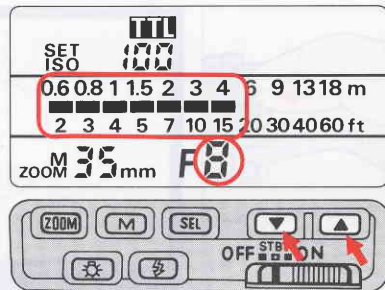

3. Using the adjustment buttons, select the appropriate aperture to match the shooting distance.

For example:

With the zoom setting at 35mm and film speed index at ISO 100, selecting $f/8$ lets you take pictures of subjects 0.6m to 4m (approx. 2ft. to 15ft.) away.

Shooting distance range varies according to aperture value, film speed and/or zoom setting. For

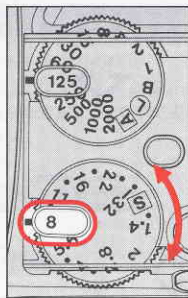
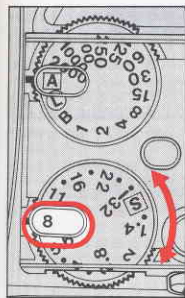

4. Set your chosen aperture.

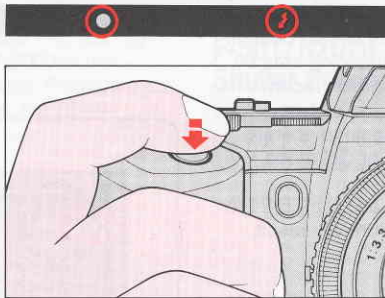

5. Lightly press the shutter release button and confirm the ready-light and in-focus indicator are on.

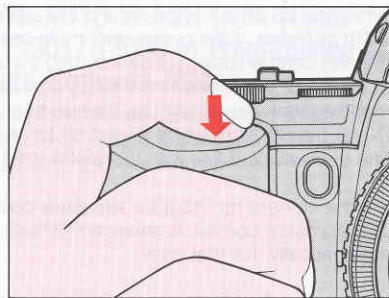

6. Fully depress the shutter release button to take the picture.

• For blinking ready-light warning, see pages 12 to 13.

shooting distance range, see page 69.

AUTOMATIC BALANCED FILL-FLASH

When the SB-24 is turned off and the scene's brightness is EV10 or higher, if the computer's multi-segment sensor detects that the central subject is darker than the surrounding area by at least 1.5EV, the viewfinder ready-light LED blinks, recommending that you should use flash to brighten the picture. (Note: the SB-24 must be turned off for this signal to operate. The LED will not blink with the SB-24 in STBY or ON mode.)

Set the camera for Program exposure control and the SB-24 for TTL exposure control. A balanced fill-flash picture will result, automatically. It's that easy.

When using the SB-24 or any other flash in the F-401s/N4004s hot shoe, built-in speedlight must remain in the down position. You cannot use both speedlights at the same time. Using the SB-24 relieves the camera's power supply from operating the built-in flash, and you can expect the camera's motor to be able to power more rolls of film.

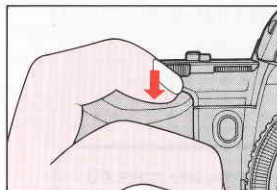
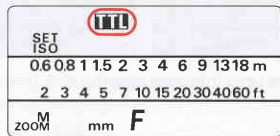
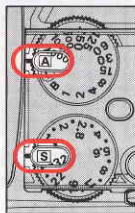

TTL AUTO FLASH WITH OTHER CAMERAS

(with Nikon F-501/N2020, F-301/N2000, FA, FE2 or FG)

With a Nikon F-501/N2020, F-301/N2000, FA, FE2 or FG camera, the SB-24 set at TTL provides standard TTL flash light output control. With the F-501/N2020, F-301/N2000 in programmed or shutter-priority auto exposure mode, Programmed TTL auto flash will be selected. In other cases, the SB-24 performs TTL auto flash.

PROGRAMMED TTL AUTO FLASH (with Nikon F-501/N2020 or F-301/N2000 in Programmed or Shutter Priority Auto Exposure Mode)

Programmed TTL auto flash simplifies camera/flash operations, allowing you to concentrate on picture composition without worrying about exposure settings, including aperture.

For correct exposure in TTL auto flash mode, use film within the range specified below:

F-501/N2020 and F-301/N2000	ISO 25 to 1000
FA, FE2 and FG	ISO 25 to 400

For programmed TTL auto flash operation, use AI-S type* lenses *only*.

**AI-S type lenses include AF Nikkor, Nikkor lens with a built-in CPU and Series E lenses. Each lens shows the minimum aperture in orange at the aperture indexing post on the aperture ring. Lenses modified for AI operation cannot be used for this mode.*

- * For autofocus operation with the F-501/N2020, set the camera's focus mode to Single Servo Autofocus. (For details about autofocus flash photography, see pages 64 to 65).
- * Set the camera's film advance mode to single-frame shooting.

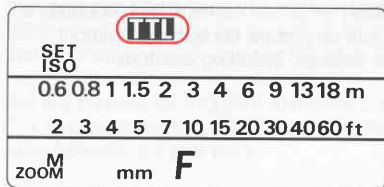
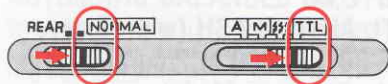

F-501/N2020

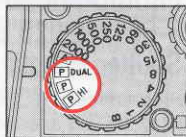

F-301/N2000

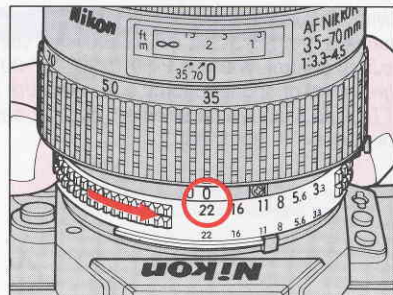
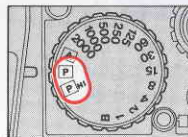

1. Set the SB-24's flash mode selector to TTL, and the flash sync mode selector to NORMAL.

2. Set the camera's exposure mode to programmed auto exposure mode (P DUAL*, P, or P HI).

3. Set the lens to its minimum aperture (highest f-number).

* For F-501/N2020 only.

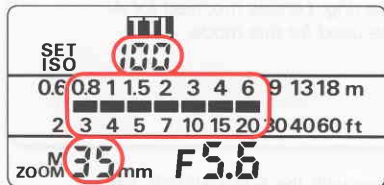

4. Make sure the shooting distance is within the flash range. Refer to chart for flash range at each ISO film speed.

Unit: meters (feet)

ISO film speed						Zoom setting					
800*	400	200	100	50	25	24mm	28mm	35mm	50mm	70mm	85mm
16	11	8	5.6	4	2.8	0.7-5.3 (2.2-17)	0.7-5.6 (2.4-18)	0.8-6.3 (2.7-20)	1.0-7.4 (3.1-24)	1.1-8.3 (2.5-27)	1.1-8.8 (3.7-29)

* With ISO 1000 film, usable aperture is 16 + 1/3 f/stops.

For example:

With the zoom setting at 35mm and film speed index at ISO 100, you can take pictures of subjects 0.8m to 6.3m (approx. 2.7ft. to 20ft.) away.

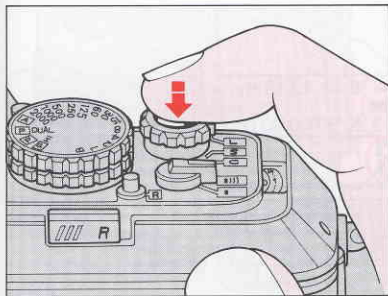

5. Lightly press the shutter release button and confirm the ready-light and in-focus indicator are on.

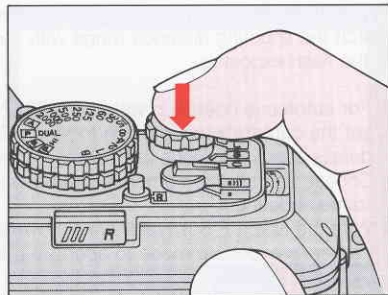
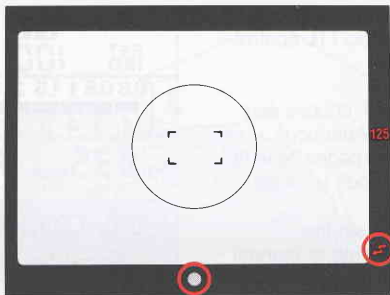

6. Fully depress the shutter release button to take the picture.

• For blinking ready-light warning, see pages 12 to 13.

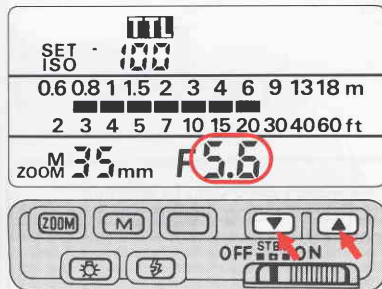

For a convenient reference, use the adjustment buttons to set the aperture (f-number) in the SB-24's LCD panel, as indicated by the chart.

TTL AUTO FLASH

TTL Auto Flash lets you select any aperture from f/1.4 to f/32 to match the shooting distance range with automatic TTL control of the flash exposure.

- * For autofocus operation with the F-501/N2020, choose and set the camera's focus mode to Single Servo Autofocus. (For details about autofocus flash photography, see pages 64 to 65).
- * Choose and set the camera's film advance mode to single-frame shooting.
- * With the Nikon F-501/N2020 or F-301/N2000, set the camera's exposure mode to aperture-priority auto or manual exposure mode.

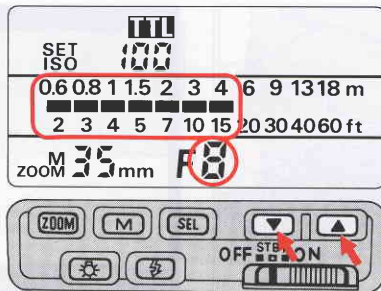

2. Using the adjustment buttons, select the aperture that best matches the shooting distance.

For example:

With the zoom setting at 35mm and the film speed index at ISO 100, selecting f/8 lets you take pictures of subjects 0.6m to 4m (approx. 2ft. to 15ft.) away.

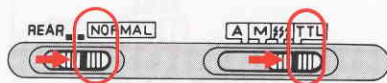

1. Set SB-24's flash mode selector to TTL, and the flash sync mode selector NORMAL.

Shooting distance range varies according to aperture value, film speed and/or zoom setting. For shooting distance range, see page 69.

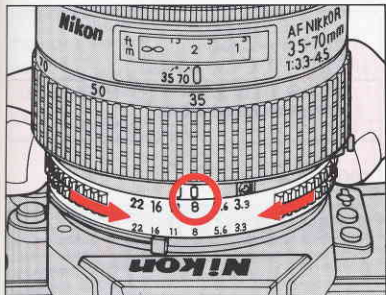

3. Set your chosen aperture.

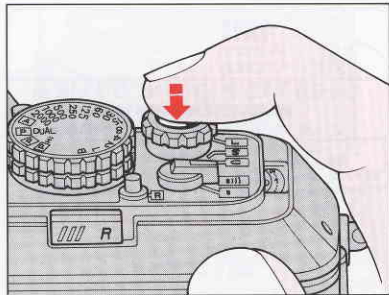

4. Lightly press the shutter release button and confirm the ready-light and in-focus indicator are on.

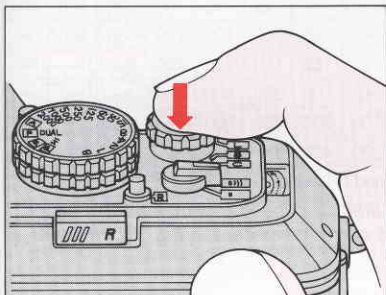
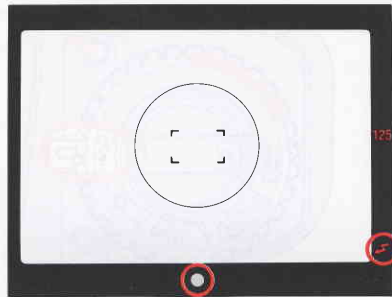

5. Fully depress the shutter release button to take the picture.

- For *blinking ready-light warning*, see pages 12 to 13.

EXPOSURE COMPENSATION WITH CAMERA'S EXPOSURE DIAL

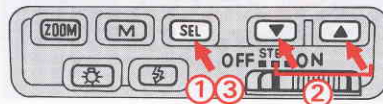
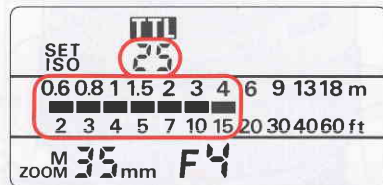
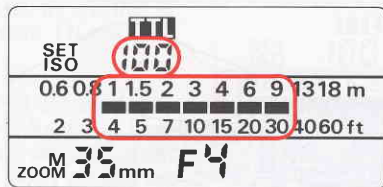
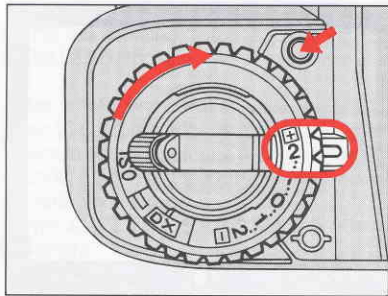

Some camera models include an EV compensation control. Using this control you can modify the exposure to make your picture lighter or darker. To make the picture lighter, use + compensation. For darker pictures use - compensation. How much compensation you choose depends on how much you want to modify the resulting picture.

The shooting distance range for TTL automatic flash operation varies with the amount of exposure compensation.

For example:

With ISO film, an aperture of $f/4$, and a zoom setting of 35mm, if you set the camera's exposure compensation dial at +2, the flash shooting distance range—which is 1m to 9m (approx. 4ft. to 30ft.) at ISO 100—shifts to 0.6m to 4m (approx. 2ft. to 15ft.) at ISO 25.

Exposure compensation value	+3	+2	+1	0	-1	-2	-3	-4	-5
25	—	—	—	25	50	100	200	400	800*
50	—	—	25	50	100	200	400	800*	—
100	—	25	50	100	200	400	800*	—	—
200	25	50	100	200	400	800*	—	—	—
400	50	100	200	400	800*	—	—	—	—
800/1000*	100	200	400	800*	—	—	—	—	—

* For Nikon F-501/N2020 and F-301/N2000 only.

- Be sure the compensated film speed is within the film speed range that guarantees correct exposure in the TTL mode of each camera.

FILL-FLASH IN TTL AUTO FLASH MODE

When using the SB-24 for fill-flash photography with a Nikon camera other than F4, F-801/N8008 or F-401s/N4004s, balance the exposure for both subject and background in the following manner.

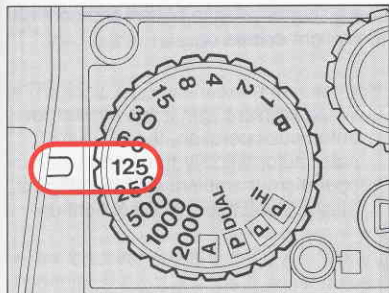

1. Manually set the camera shutter speed to the flash synchronization speed or slower.

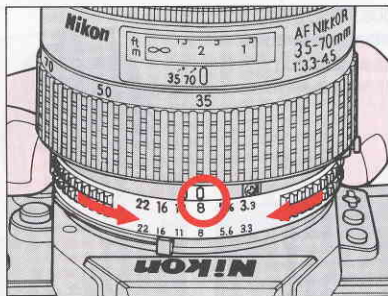

2. Frame the background in the camera viewfinder, then turn on the camera's exposure meter to determine the appropriate aperture for a correct background exposure, and set the aperture.

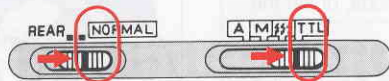
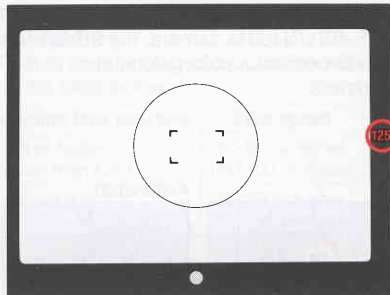

3. Set the SB-24's flash mode selector to TTL and the flash sync mode selector to NORMAL, then turn on the SB-24 and take the picture.

AUTOFOCUS FLASH PHOTOGRAPHY (with Nikon F4, F-801/N8008, F-501/N2020 or F-401s/N4004s)

When combined with the Nikon F4, F-801/N8008, F-501/N2020 or F-401s/N4004s camera, the SB-24's AF illuminator enables you to perform autofocus operation in dim light and total darkness.

F4

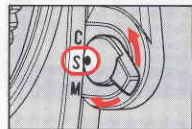

F-501/N2020

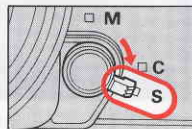

F-401s/N4004s

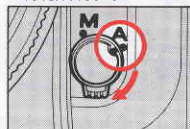

F-801/N8008

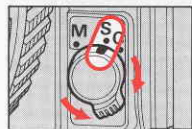

1. Set the Nikon F4, F-801/N8008 or F-501/N2020 focus mode selector to S for Single Servo Autofocus mode, or set the F-401s/N4004s to A for autofocus mode.

Set the camera's exposure mode and metering system selector and the SB-24's flash mode selector as desired.

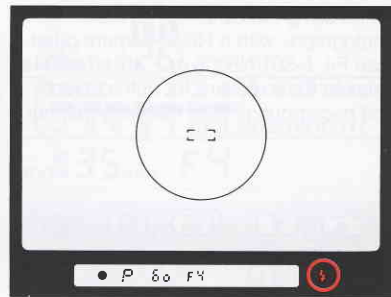
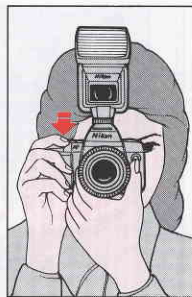

2. Lightly press the camera shutter release button and confirm that the viewfinder ready-light comes on.

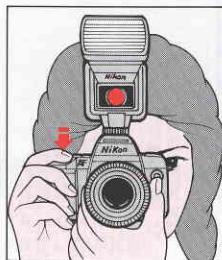

When ambient light is insufficient for autofocus operation, the AF illuminator automatically turns on to start operation. If ambient light is sufficient, the AF illuminator does not light up.

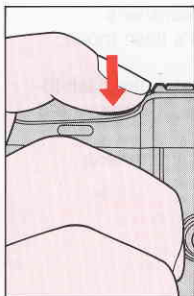
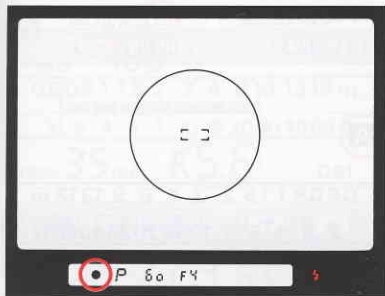

3. Confirm the in-focus indicator lights up, then fully depress the shutter release button.

- The focal lengths that can be used with the AF illuminator and AF Nikkor lenses are as follows:

	Range
F-501/N2020:	35mm to 105mm
F4, F-801/N8008, F-401s/N4004s:	24mm to 105mm

- The focusing range with an AF Nikkor 50mm f/1.8 for a general subject with 35% reflectance at normal temperatures is approx. 1m to 8m (3.2ft to 26.2ft).

For greater depth of field

In programmed TTL auto flash photography, use film with a speed specified in the table below:

	Maximum lens aperture	Film speed
Lens only	f/2.8 or faster Slower than f/2.8	ISO 50 or higher ISO 100 or higher
F-501/N2020 with TC-16AS	f/1.4 or f/1.2 f/1.8, f/2, f/2.5 or f/2.8	ISO 50 or higher ISO 100 or higher

In other flash operation modes, set the lens aperture as follows:

	Maximum lens aperture	Aperture setting
Lens only	f/2.8 faster Slower than f/2.8	f/2.8 or larger f-number (f/2.8, f/4, f/5.6, etc.) f/5.6 or larger f-number (f/5.6, f/8, f/11, etc.)
F-501/N2020 with TC-16AS	f/1.4 or f/1.2 f/1.8, f/2, f/2.5 or f/2.8	f/2 or larger f-number (f/2, f/2.8, f/4, etc.) f/4 or larger f-number (f/4, f/5.6, f/8 etc.)

Note: With Nikon F4, F-801/N8008 or F-401s/N4004s, sets the lens aperture to f/2.8 or faster.

NON-TTL AUTO **A** FLASH—For Shooting with Varied Lens Apertures

To use various lens apertures for the same subject or when your camera/lens combination is incompatible with TTL auto flash mode, set the SB-24's flash mode selector to A for non-TTL auto flash operation.

In non-TTL auto flash shooting, light output varies automatically to match the flash-to-subject distance, but instead of light being measured through the lens, it is measured by the light sensor on the front of the SB-24.

The SB-24 can be used in non-TTL auto flash mode with any Nikon camera/lens combination.

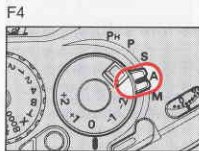

F-801/N8008

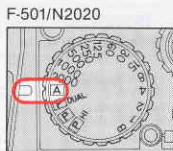
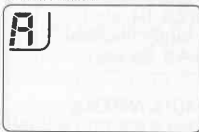

F-301/N2000

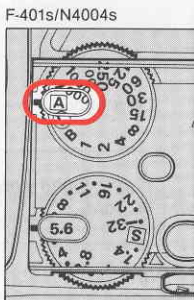
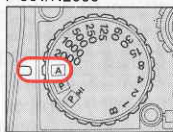

1. Set the camera's exposure mode to aperture-priority auto or manual exposure mode.



A
ISO
0.6 0.8 1 1.5 2 3 4 6 9 13 18 m
2 3 4 5 7 10 15 20 30 40 60 ft
ZOOM mm F4

2. Set the SB-24's flash mode selector to A, and the flash sync mode selector to your choice of NORMAL or REAR.

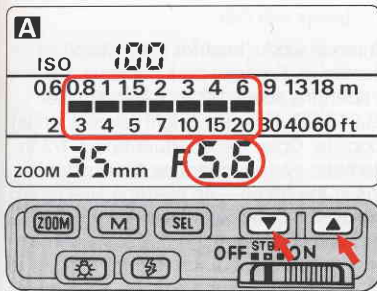

- 3.** Using the adjustment buttons, select an appropriate aperture making sure the subject is within the allowed shooting distance.

For example:

With the zoom set at 35mm and the film speed index at ISO 100, you can select f/2, 2.8, 4, 5.6, 8 or 11. At f/5.6, you can take pictures of subjects 0.8m to 6m (3ft. to 20ft.) away.

Shooting distance range varies according to film speed, aperture value and/or zoom setting. For shooting distance range, see page 69.

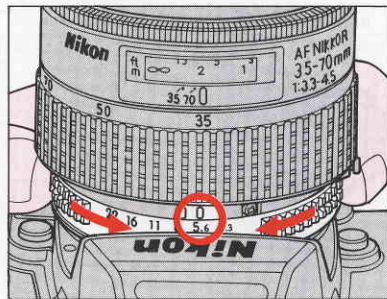

- 4.** Set your chosen aperture.

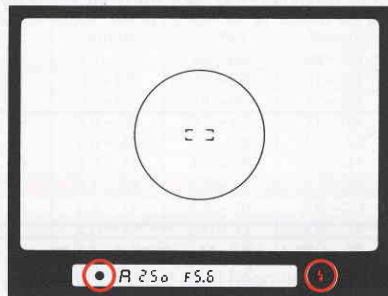
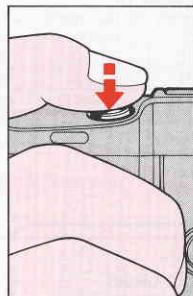

- 5.** Lightly press the shutter release button and confirm the ready-light and in-focus indicator have come on.

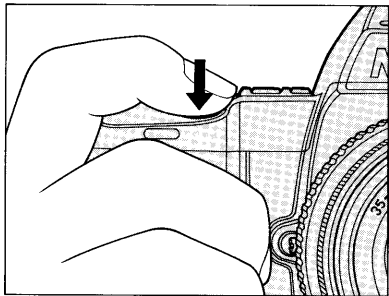

6. Fully depress the shutter release button to take the picture.

• *For blinking ready-light warning, see pages 12 to 13.*

EXPOSURE COMPENSATION IN NON-TTL AUTO FLASH MODE

The Non-TTL Auto Flash mode works best for subjects of average (18% gray) reflectance. For very dark subjects, we recommend closing the aperture about 1/2 to 1 stop smaller than indicated on the SB-24 LCD. For very bright (almost white) subjects, it is just the opposite. Open the aperture about 1/2 to 1 stop. Similarly, the automatic system operates best under average indoor conditions in the home—an average-size room having white ceilings approx. 2.5 to 3 meter (8 to 10 feet) high. In a very large room, or in one with very high ceilings, such as an auditorium, if you are more than about 4.5 to 6 meters (15 to 20 feet) from the subject, you should experiment by opening the aperture 1 to 2 stops wider than the LCD indicates. Since there is no way to anticipate any specific condition, you may want to take a few pictures using exposure bracketing.

Test Firing for Non-TTL Auto Flash

Push the open-flash button. If the ready-light blinks, select a wider aperture or move closer to the subject.

www.butkus.us

USABLE APERTURES/SHOOTING DISTANCE RANGE IN TTL AND NON-TTL AUTO FLASH MODES

Unit: meters

		ISO film speed						Shooting distance range						
		1600**	800*	400	200	100	50	25	Zoom set at 24mm	Zoom set at 28mm	Zoom set at 35mm	Zoom set at 50mm	Zoom set at 70mm	Zoom set at 85mm
f/stop			2	1.4					5.2~20	5.7~20	6.4~20	7.5~20	8.4~20	8.9~20
			2.8	2	1.4				3.7~20	4.0~20	4.5~20	5.2~20	5.9~20	6.3~20
			4	2.8	2	1.4			2.6~20	2.9~20	3.2~20	3.7~20	4.2~20	4.4~20
		8	5.6	4	2.8	2	1.4		1.8~15	2.0~16	2.3~18	2.6~20	3.0~20	3.2~20
		11	8	5.6	4	2.8	2	1.4	1.3~10	1.5~11	1.6~12	1.8~14	2.1~16	2.3~17
		16	11	8	5.6	4	2.8	2	1.0~7.5	1.0~8.0	1.2~9.0	1.3~10	1.5~11	1.6~12
		22	16	11	8	5.6	4	2.8	0.7~5.3	0.7~5.6	0.8~6.3	1.0~7.4	1.1~8.3	1.1~8.8
		32	22	16	11	8	5.6	4	0.6~3.7	0.6~4.0	0.6~4.5	0.7~5.2	0.8~5.8	0.8~6.2
			32	22	16	11	8	5.6	0.6~2.6	0.6~2.8	0.6~3.1	0.6~3.7	0.6~4.1	0.6~4.4
				32	22	16	11	8	0.6~1.8	0.6~2.0	0.6~2.2	0.6~2.6	0.6~2.9	0.6~3.1
				32	22	16	11	0.6~1.3	0.6~1.4	0.6~1.5	0.6~1.8	0.6~2.0	0.6~2.2	
					32	22	16	0.6~0.9	0.6~1.0	0.6~1.1	0.6~1.3	0.6~1.4	0.6~1.5	

Unit: feet

		ISO film speed						Shooting distance range						
		1600**	800*	400	200	100	50	25	Zoom set at 24mm	Zoom set at 28mm	Zoom set at 35mm	Zoom set at 50mm	Zoom set at 70mm	Zoom set at 85mm
f/stop			2	1.4					17~66	19~66	21~66	25~66	28~66	29~66
			2.8	2	1.4				12~66	14~66	15~66	17~66	20~66	21~66
			4	2.8	2	1.4			8.6~66	9.3~66	11~66	12~66	14~66	15~66
		8	5.6	4	2.8	2	1.4		6.1~49	6.6~52	7.4~59	8.6~66	9.7~66	11~66
		11	8	5.6	4	2.8	2	1.4	4.4~34	4.7~37	5.3~41	6.0~48	6.9~54	7.3~58
		16	11	8	5.6	4	2.8	2	3.1~24	3.3~26	3.7~29	4.3~34	4.9~38	5.2~41
		22	16	11	8	5.6	4	2.8	2.2~17	2.4~18	2.7~20	3.1~24	3.5~27	3.7~29
		32	22	16	11	8	5.6	4	2.0~12	2.0~13	2.0~14	2.2~17	2.5~19	2.6~20
			32	22	16	11	8	5.6	2.0~8.7	2.0~9.2	2.0~10	2.0~12	2.0~13	2.0~14
				32	22	16	11	8	2.0~6.1	2.0~6.5	2.0~7.3	2.0~8.6	2.0~9.6	2.0~10
				32	22	16	11	2.0~4.3	2.0~4.6	2.0~5.2	2.0~6.0	2.0~6.8	2.0~7.2	
					32	22	16	2.0~3.0	2.0~3.3	2.0~3.6	2.0~4.3	2.0~4.8	2.0~5.1	

☐: Programmed TTL auto flash with Nikon F-501/N2020, F-401s/N4004s (within ISO 25-400) and F-301/N2000.

☐: Non-TTL auto flash

* For TTL auto flash with Nikon F4, F-801/N8008, F-501/N2020 or F-301/N2000; with ISO 1000 film, usable apertures will be smaller by 1/3 EV.

** For non-TTL auto flash only.

MANUAL FLASH—You Make All The Decisions

With the SB-24's flash mode selector at M, you can manually choose your desired level of flash power: full power (1/1), 1/2, 1/4, 1/8, or 1/16.

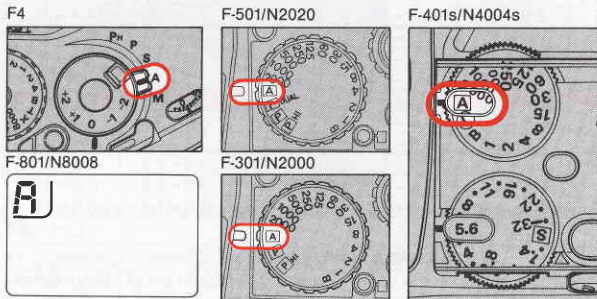

1. Set the camera's exposure mode to aperture-priority auto or manual.



ISO
0.6 0.8 1 1.5 2 3 4 6 9 13 18 m
2 3 4 5 7 10 15 20 30 40 60 ft
ZOOM mm F M/ i

2. Set the SB-24's flash mode selector to M, and the flash sync mode selector to your choice of NORMAL or REAR.

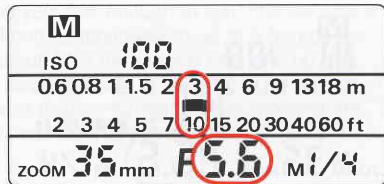
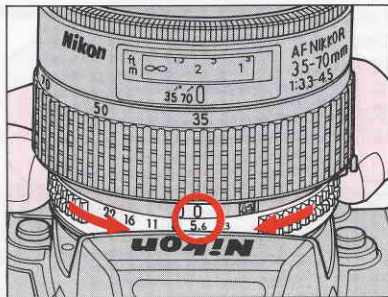
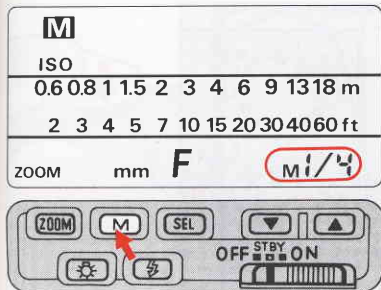

3. Press the "M" button to control the amount of light. The light output changes as follows, and is shown in the LCD panel.

-1/1 -1/2 -1/4 -1/8 -1/16-

4. Set an appropriate aperture, according to subject distance.

When using the Nikon F4 or F-801/N8008 with a lens having a built-in CPU:

SB-24's LCD panel automatically indicates your chosen aperture and the shooting distance mark ■ appears on the distance scale. Set the camera's aperture to match your desired shooting distance.

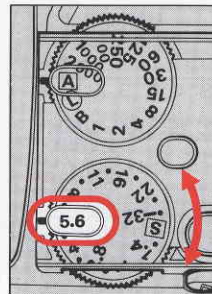
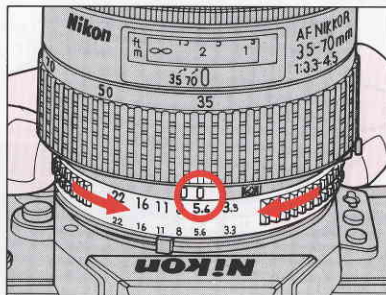
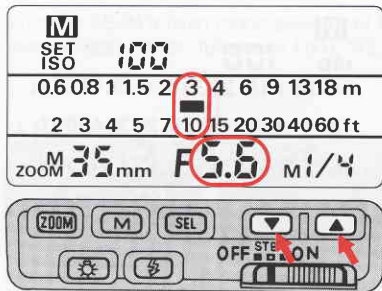

With other combinations:

To set the aperture in the LCD panel, press the adjustment button until the shooting distance mark ■ corresponds to your desired distance.
Set the indicated aperture.

For example:

With the zoom set at 35mm and the film speed index at ISO 100, selecting f/5.6 and light output 1/4 lets you take pictures of subjects 3m (approx. 10ft) away.

Shooting distance varies according to aperture value, film speed, zoom setting and/or amount of light.

You can also determine aperture using the SB-24's guide number (GN). For details, see page 81.

www.butkus.us

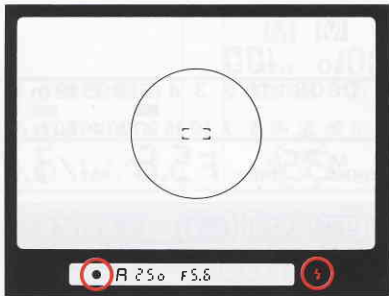
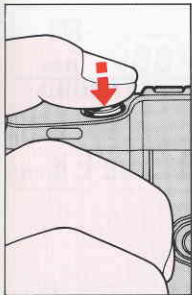

5. Lightly press the shutter release button and confirm the ready-light and in-focus indicator have come on.
 • For blinking ready-light warning, see pages 12 to 13.

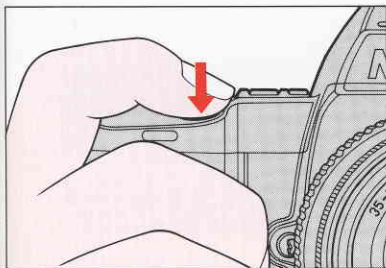

6. Fully depress shutter release button to take the picture.

SYNCHRONIZATION IN CONTINUOUS SHOOTING

The SB-24 is able to recycle fast enough to synchronize with a motor-driven camera firing continuously at up to 6 frames per second at 1/16 light output. This means you can take up to 8 flash pictures in rapid succession.

The maximum number of flashes for continuous shooting are listed below. Batteries must be fresh to achieve the rates indicated.

Batteries	Light output	Sync speed (frames per second)	Maximum number of flashes (approx.)
AA-type batteries inside SB-24	M1/16	Slower than 6 Slower than 3.3	8 10
	M1/8	Slower than 6 Slower than 3.3	4 5
AA-type batteries inside SB-24 plus C-type alkaline-manganese batteries inside optional DC Unit SD-7	M1/16	Slower than 6 Slower than 3.3	10 30
	M1/8	Slower than 6 Slower than 3.3	5 9

Note: Never fire the flash more than 40 times at 1/8 light output. After each major flash shooting, let the flash rest at least 10 minutes before firing again.

MANUAL FILL-FLASH

Outdoor fill-flash used with manual mode requires that you choose the flash-to-daylight ratio that gives the desired effect. As with automatic fill-flash, your goal is to have the flash brighten the shadowy areas of the picture, while leaving the brighter highlights unaffected. To do this you must set up your shot so the flash exposure will be underexposed by at least one or two f/stops. The following procedure is just a guideline for experimentation to enable you to get your desired effect.



M
ISO
0.6 0.8 1 1.5 2 3 4 6 9 13 18 m
2 3 4 5 7 10 15 20 30 40 60 ft
ZOOM mm F mi/i

Set the SB-24's flash mode selector to M and the flash sync mode selector to your choice of NORMAL or REAR, then turn on the SB-24.

M
ISO
100
0.6 0.8 1 1.5 2 3 4 6 9 13 18 m
2 3 4 5 7 10 15 20 30 40 60 ft
ZOOM M 35 mm F 5.6 mi/i



1. Using manual adjustment, set the SB-24's zoom head to correspond to the focal length of the lens you are using.

M	
ISO	100
0.6 0.8 1 1.5 2 3 4 6 9 13 18 m	
2 3 4 5 7 10 15 20 30 40 60 ft	
ZOOM M 35mm F5.6 M1/1	

M	
ISO	100
0.6 0.8 1 1.5 2 3 4 6 9 13 18 m	
2 3 4 5 7 10 15 20 30 40 60 ft	
ZOOM M 35mm F5.6 M1/1	

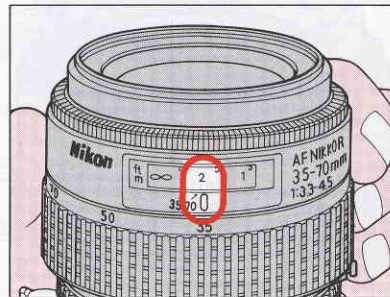

2. Ensure that the ISO display on the SB-24 corresponds to the ISO of the film you are using.

3. Select the desired shutter speed according to subject movement or any effect you wish to create, then adjust the lens aperture for correct exposure, according to the camera's meter. The aperture you have selected will appear on the SB-24's LCD. (At this point, you have adjusted the camera's control for the correct ambient light exposure.)

4. Focus on the subject and check the lens' focusing scale to determine the distance to the subject.

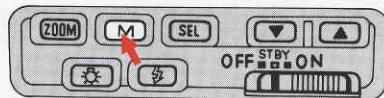
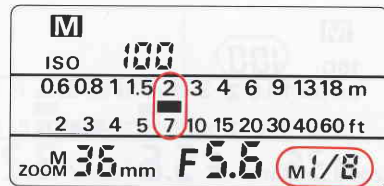
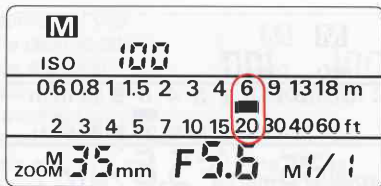
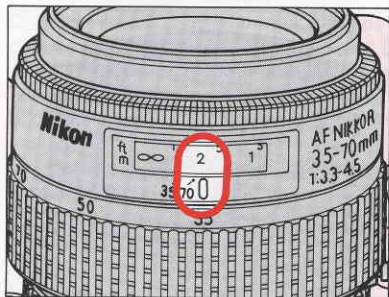

5. Referring to the distance to the subject, press the SB-24 M button until the SB-24's distance scale indicates a distance which corresponds to the actual focused distance to the subject. Now, the SB-24's LCD (lower right corner) will indicate the level of flash power needed to provide a flash exposure equal to the daylight exposure.

However, as previously noted, in order to get a good fill-flash ratio, the flash exposure should be one to two stops darker than the daylight exposure. Therefore, press the M button one or two times more. This will adjust the flash to one or two levels less light. (i.e. half the power which will reduce the exposure by one f/stop. Pressing it twice moves it to 1/4, which is two stops less than full (1/1) power.)



It is possible to approach this procedure from another point of view; that is by first adjusting the flash to the desired flash power setting, then selecting a lens aperture which is one stop smaller than that indicated by the flash, and then adjusting the shutter control for the correct available-light exposure.

Whichever method you use, you will need to make a creative decision by choosing the fill-flash ratio. We hasten to note that while you may wish to use the manual mode, when using the SB-24 with Matrix Balanced Fill-Flash, all of these steps are accomplished automatically.

REPEATING FLASH — For Multiple Exposure

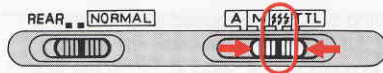
For multiple flash exposures on one frame, use the SB-24 in the  mode. The flash can be fired up to eight times on one frame, and if used in conjunction with the camera body's multiple exposure control, many more flashes can be achieved on the same frame. *Note that this feature operates only in manual exposure control mode for both the flash and the camera.*



 	
-SET-	 1 Hz
0.6 0.8 1 1.5 2 3 4 6 9 13 18 m	
2 3 4 5 7 10 15 20 30 40 60 ft	
ZOOM mm	F M 1/16

1. Set the flash mode selector to .

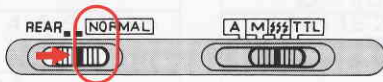

2. Set the flash sync mode selector to NORMAL.

3. Choose B (bulb) setting or a shutter speed long enough to accommodate all of the flashes you will fire. For example: 10Hz will fire the flash 10 times in one second. Firing the flash 5 times at 10Hz takes 1/2 second to occur, so you should set the shutter to a speed at least as slow as 1/2 second.

Firing the flash 6 times at 8Hz takes 6/8 second to occur. However, because your camera does not have a shutter speed of 6/8 (0.75) second, you should set it to the closest slower shutter speed, which is one second.

As you may have noted: to calculate the speed necessary for the combination of number of flashes and speed of flashes, you should divide the number of flashes by the speed of the flashes (Hz), then convert the fraction to a decimal number and set the shutter speed that corresponds to the calculated value.

4. Set the ambient light exposure using the manual exposure control mode.

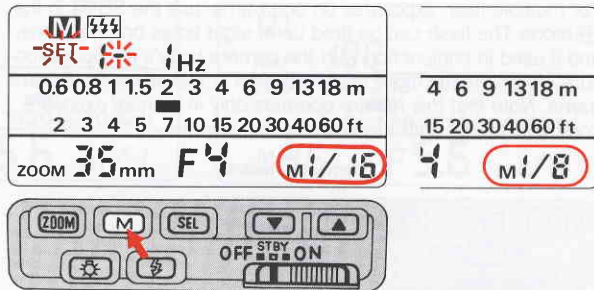

5. Press the M button to choose the required flash power level, either 1/16 or 1/8 power. The lower 1/16 power will permit more flashes per firing. The maximum number of flashes will be indicated by the LCD when you perform the next step.

Alternately choosing 1/8 or 1/16 also allows you to vary the distance to the subject, which will be indicated on the LCD distance scale.

You may also adjust for subject distance by adjusting the zoom head position. The LCD distance scale will also indicate this adjustment. Always be sure that the zoom head position is at a setting that is at least as wide as the focal length of the lens you are using. Otherwise vignetting may occur.

**6. When using Nikon F4 or F-801/
N8008 with a lens having a built-in
CPU:**

Press adjustment button ▼ to set number of flashes, and ▲ to set frequency.

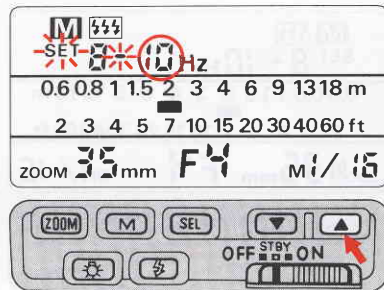
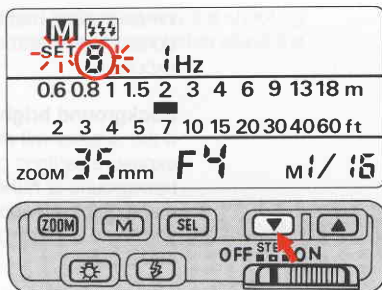

6. With other combinations:

Press the SEL button (the SEL on the LCD will blink) and select the desired number of flashes and frequency by pressing the ▼ and ▲ buttons, respectively.

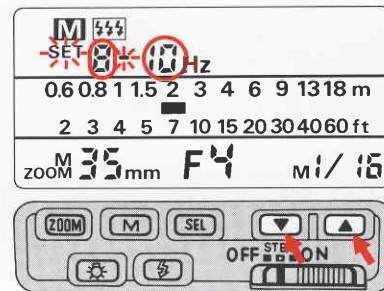
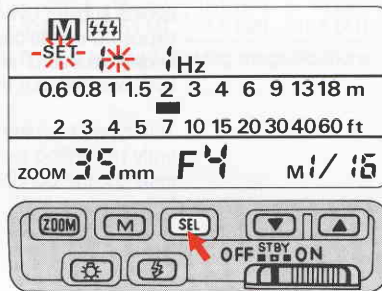

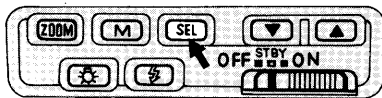
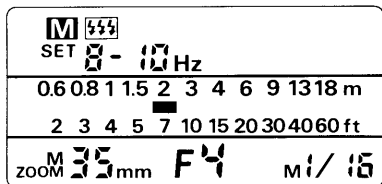

7. Press the SEL button a second time to stop the blinking display.

When making multiple exposures, there are many factors to be considered. You may want to experiment before making the final exposure.

Background brightness

If the subject will move across a relatively dark background, the exposure settings can be as indicated by the SB-24 LCD. If the background is rather bright in relation to the subject, however, the subject will appear faded in the final picture. We suggest you try to underexpose the background to make the subject stand out.

Subject overlap

If the flash frequency is so fast that each image of the subject will overlap, the portion of the film where the subjects overlap will become overexposed. Try to choose a flash frequency that avoids subject overlap or use a smaller aperture to set the exposure conditions so each exposure of the subject will be underexposed. The overlapped portions will then be less overexposed, but the non-overlapped portions will be darkened.

This type of experimental photography is exciting. For consistently rewarding results, we suggest you keep notes of all settings and conditions for future reference.

GUIDE NUMBER

In manual flash and Repeating-Flash modes, apart from checking the shooting distance in the LCD panel, you can also determine the correct f/stop using the following equation.

$$f/stop = \frac{\text{guide number}}{\text{flash-to-subject-distance}}$$

See table for the guide numbers at various film speeds.

Guide number at various film speeds

meters (feet) at ISO 100

Zoom setting Light output	24mm	28mm	35mm	50mm	70mm	85mm
1/1	30 (98)	32 (105)	36 (118)	42 (138)	47 (154)	50 (164)
1/2	21 (69)	22 (72)	25 (82)	30 (98)	33 (108)	36 (118)
1/4	15 (49)	16 (52)	18 (59)	21 (69)	23 (75)	25 (82)
1/8	10.5 (34)	11 (36)	12.5 (41)	15 (49)	16.5 (54)	18 (59)
1/16	7.5 (25)	8 (26)	9 (29)	10.5 (34)	11.5 (38)	12.5 (41)

For film other than ISO 100, multiply the above figures by the following magnifications:

ISO 25	×0.5
50	×0.71
200	×1.4
400	×2
800	×2.8
1600	×4

DIFFUSING LIGHT



Direct flash:



Bounce flash:

Diffused light softens harsh shadows and creates attractive portraits. There are two ways to diffuse light:

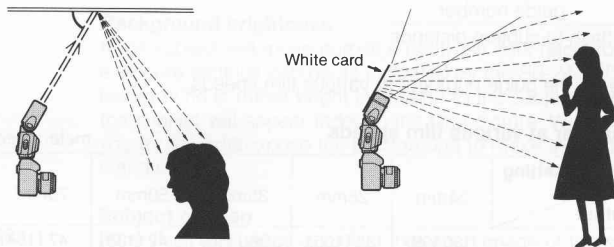

1. Bounce light off a broad reflective surface such as the ceiling or white card.

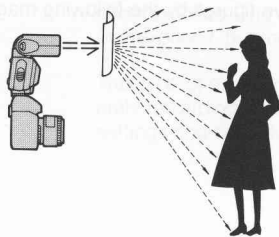

2. Use a diffuser between the flash and the subject.

www.butkus.us

BOUNCE FLASH PHOTOGRAPHY PROCEDURE

The SB-24's flash head tilts and/or rotates within the following range.

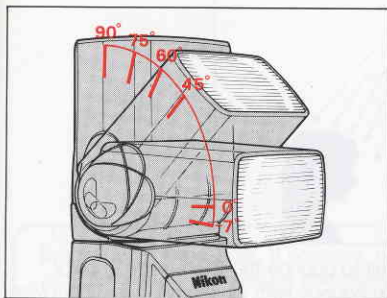

Tilting: up to 90° —front—down to -7°

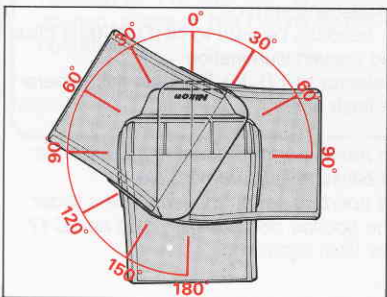
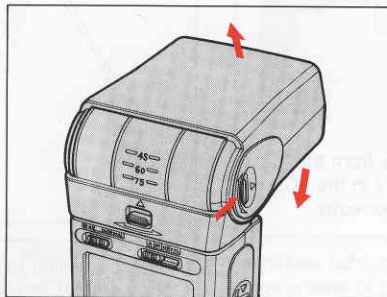

Rotation: to right 90° —front—to left 180°

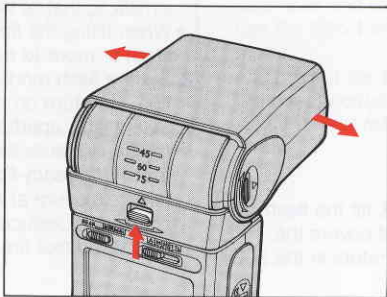

- Although the SB-24 has click stops at the most commonly used positions (except -30°), intermediate angles can also be used.
- The flash head locks at the front position. To release the lock, use the tilting lock release lever or rotating lock release lever.

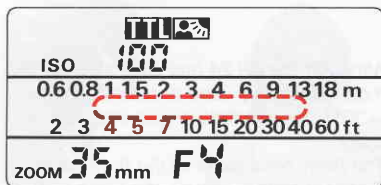

When the flash head is tilted up or rotated away from the original position, the shooting distance indicators in the LCD panel disappear, because distance cannot be correctly calculated.

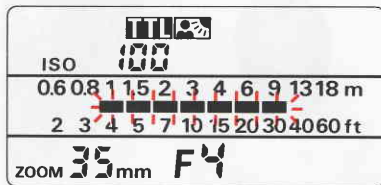

If shooting distance is within 1.5m (approx. 5ft.), tilt the flash head down to the -7° position so the flash light covers the subject. In this case, the shooting distance indicators in the LCD panel blink.

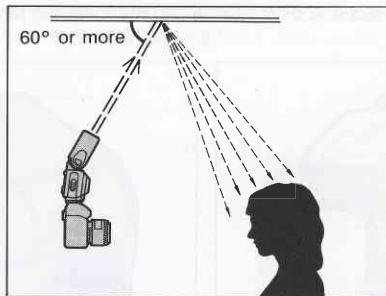

1. Select a ceiling or wall to bounce the flash from. In color photography, only use bounce with white surfaces. Otherwise, color photographs will come out with an unnatural color cast similar to that of the reflecting surface.
 - When tilting the flash head up, be sure to tilt it 60° (first click-stop) or more to avoid uneven illumination.
2. Set the flash mode selector to TTL for TTL auto flash operation, then turn on the flash unit.
3. Select your aperture.
 - *In non-TTL auto flash mode, perform a test firing. After the test, if the ready-light blinks to indicate possible underexposure at the aperture set on the lens, use a wider aperture or reduce the bounce distance (by using an SC-17 cord), and test fire the flash again.*

USING A DIFFUSER

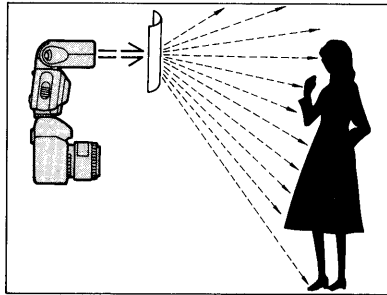

Bracket your exposures. If possible, take additional shots with the camera's exposure compensation dial set in the + or - direction (not possible with Nikon F-401s/ N4004s) for TTL auto flash operation, or with the lens opened up one or two f/stops for non-TTL auto flash operation.

To diffuse light, place a translucent material, such as one or more sheets of tracing paper between the flash and the subject. For optimum results, experiment with different flash-to-diffuser distances and more than one diffuser. When using a diffuser, use the SB-24 in either TTL auto or manual flash mode.

- *To protect the diffuser from burning, be sure it does not come in direct contact with the SB-24's flash head.*
- *Avoid direct reflection from the translucent material to the lens.*

MULTIPLE FLASH PHOTOGRAPHY

If you have another flash unit, you can use it as a secondary light source for multiple flash photography. When you use only one flash unit in front of a subject, harsh shadows may be produced or light may not reach the background. Using more than one flash unit helps you solve these problems.

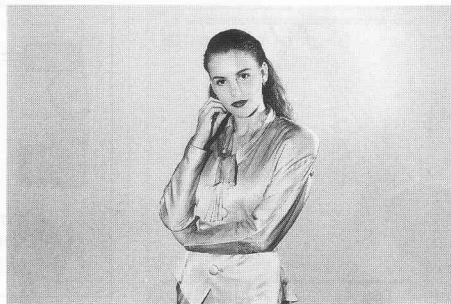

With three flash units

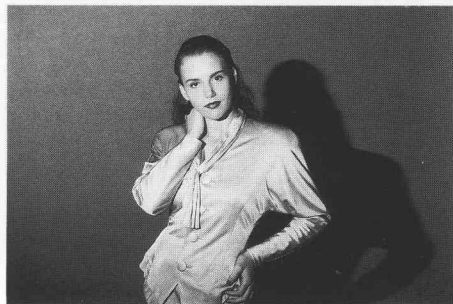
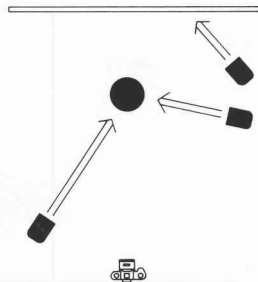

With one flash unit



With three flash units

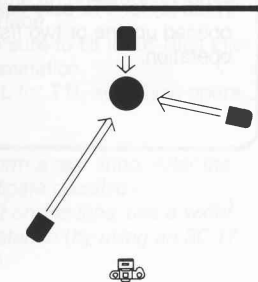

www.butkus.us

TTL MULTIPLE FLASH PHOTOGRAPHY

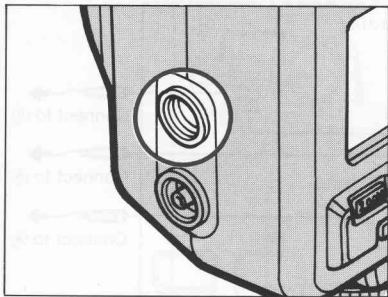

As the master flash unit, use Nikon Speedlight SB-24, SB-23, SB-22, SB-21B, SB-20, SB-18, SB-16B or SB-15 connected to an F4, F-801/N8008, F-501/N2020, F-401s/N4004s, F-301/N2000, FA, FE2 or FG camera, and for the slave flash unit(s), use the SB-24, SB-22, SB-21B, SB-20, SB-18, SB-17, SB-16A, SB-16B and/or SB-15. Up to 5 flash units can be used.

For TTL multiple flash photography, connect the flash units via the speedlight's TTL multiple flash terminal using optional TTL Multi-Flash Sync Cord SC-18 (1.5m) and/or SC-19 (3m). Because SB-23, SB-22, SB-21B, SB-20, SB-18 and SB-15 do not have a TTL multiple flash terminal, it is necessary to use TTL Remote Cord SC-17 or SC-24* when using these flash units as a master flash unit. To use SB-22, SB-21B, SB-20, SB-18 and/or SB-15 as slave flash units, use TTL Multi-Flash Adapter AS-10. When using SB-140, SB-14 and/or SB-11 for TTL multiple flash photography, you should also use TTL Remote Cord SC-23.

* Used for F4 with DW-20 or DW-21 attached.

TTL auto flash is not possible when using Nikon F-401s/N4004s with SB-11/14/140 (even with SC-23) or SB-21B. These speedlights cannot be used for TTL multiple flash either, even as slave flash units.

See system chart on the following pages.

- Set the power switch of slave flash units at ON position, not at STBY. When using SB-24, SB-22 or SB-20 as a slave unit with the power switch at STBY position, lightly pressing the shutter release button does not activate them. The same thing also happens when you set SB-23 to TTL (STBY); do not use SB-23 as a slave flash unit.

SYSTEM CHART FOR TTL MULTIPLE FLASH

*The SB-11, SB-14, SB-140 and SB-21B cannot be used with Nikon F-401s/N4004s either as a master or slave flash unit

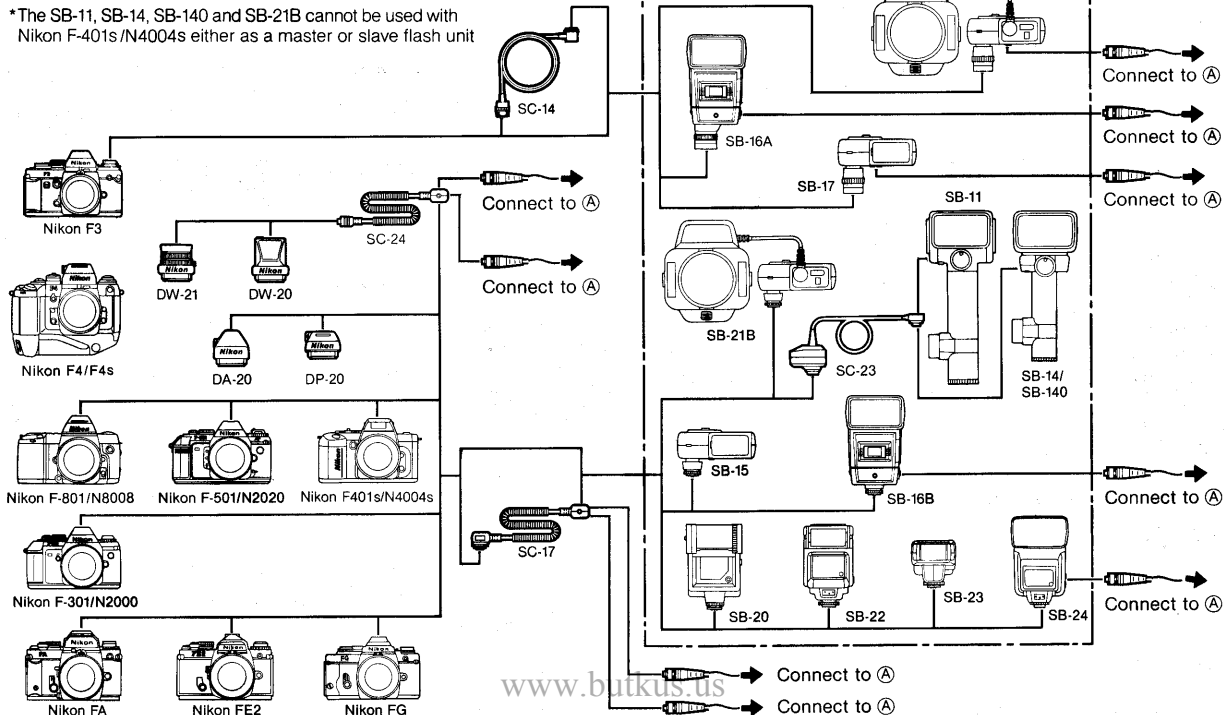

www.butkus.us

Slave flash unit

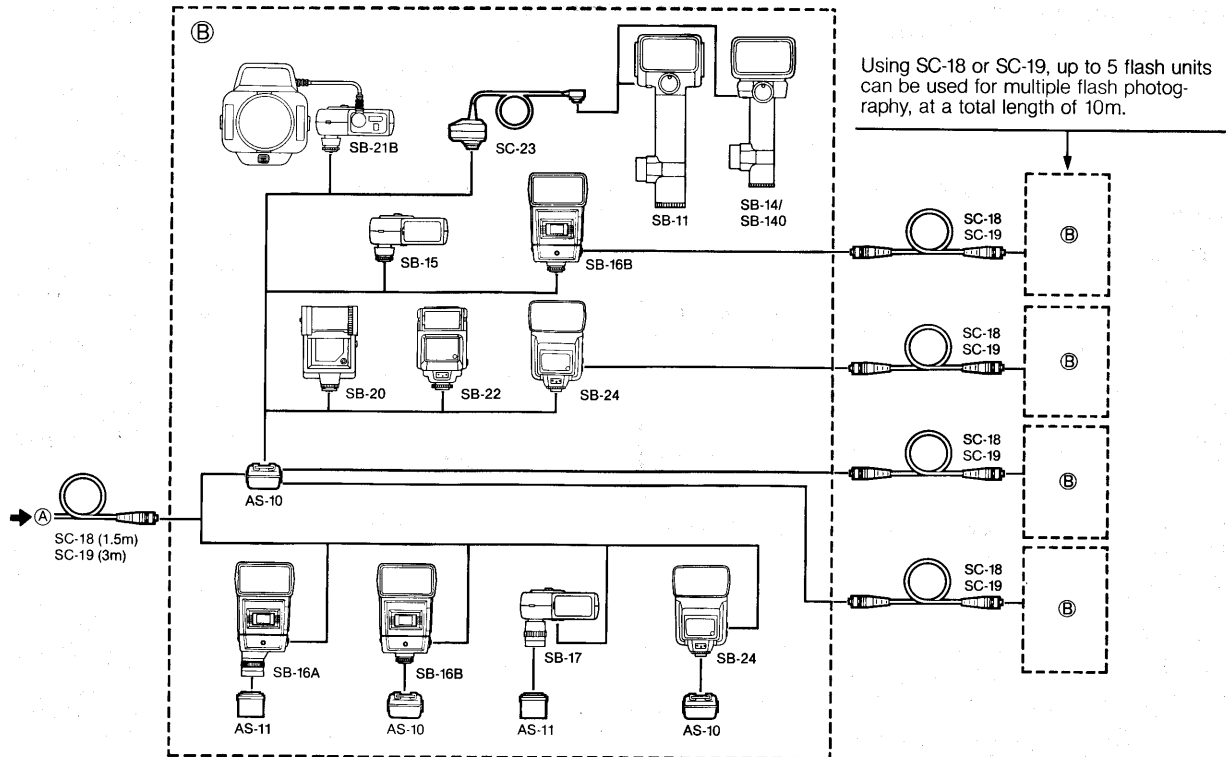

ACCESSORIES FOR TTL MULTIPLE FLASH

TTL Remote Cord SC-17

For Programmed TTL auto flash operation or TTL auto flash operation when using the SB-24 off the Nikon F-801/N8008, F-501/N2020, F-401s/N4004s, F-301/N2000, FA, FE2 or FG camera, use coiled cord SC-17. The SC-17 provides automatic sync speed setting and the same ready-light viewfinder indication as if the flash unit were directly mounted on the camera. SC-17 comes with two TTL multiple flash terminals and one tripod socket. The SC-17 is approx. 1.5m (4.9ft).

TTL Remote Cord SC-24

For TTL auto flash operation when using the SB-24 off the Nikon F4 camera fitted with either the 6X High-Magnification Finder DW-21 or Waist-Level Finder DW-20, use SC-24 instead of SC-17.

The SC-24 also comes with two TTL multiple flash terminals and one tripod socket. The SC-24 is approx. 1.5m(4.9ft).

TTL Multi-Flash Adapter AS-10

When using more than three flash units for TTL multiple flash operation, use the Multi-Flash Adapter AS-10, an adapter with three multiple flash terminals and one tripod socket. (Requires SC-18 or SC-19 for each flash use.)

TTL Multi-Flash Sync Cords SC-18 and SC-19

To connect the flash units for TTL multiple flash operation, use Sync Cord SC-18 or SC-19.

The SC-18 is approx. 1.5m (4.9ft) long; the SC-19, 3m (9.8ft) long.

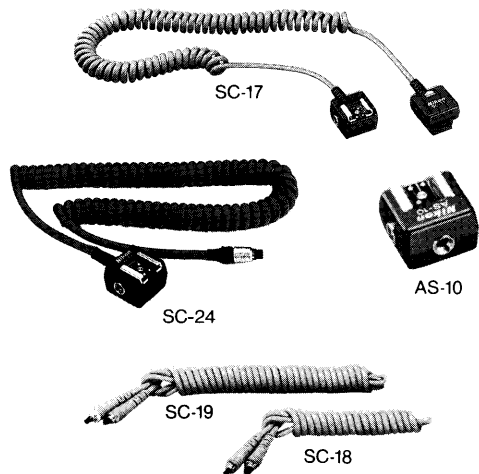

MANUAL MULTIPLE FLASH PHOTOGRAPHY

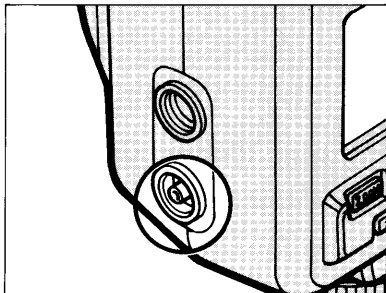

Connect SB-24 and other flash units via the SB-24's multiple flash terminal, using optional Nikon Sync Cord SC-11 or SC-15. For correct exposure in manual multiple flash operation, be sure all flash units are set at manual flash mode.

Caution: To avoid damage to flash units or incorrect operation, never mix Nikon Speedlights with flash units of other manufacturers.

For multiple flash photography using Nikon F4 or F-801/N8008, if the electric current in the synchro circuit exceeds a certain level, you may not be able to take a second shot after taking the first shot. Take care that the combined total of the coefficients (numbers shown in parenthesis below) for all speedlight's used at any one time does not exceed 20 at 20°C/68°F (13 at 40°C/104°F).

SB-24 (1)	SB-23 (4)	SB-22 (6)	SB-21 (4)	SB-20 (9)
SB-19 (2)	SB-18 (16)	SB-17 (4)	SB-16 (4)	SB-15 (4)
SB-14 (1)	SB-12 (1)	SB-11 (1)		

If you are unable to take a second shot, disconnect the master speedlight from the camera, or turn each of the speedlights off and on once. This resets the circuits so you can resume shooting.

CLOSE-UP FLASH PHOTOGRAPHY IN TTL AUTO FLASH MODE

When used with the Nikon F4, F-801/N8008, F-501/N2020, F-401s/N4004s, F-301/N2000, FA, FE2 or FG, optional TTL Remote Cord SC-17 or SC-24, lets you perform flash shooting with a subject closer than 0.6m (approx. 2ft.).

1. Connect the SB-24 to the camera using Remote Cord SC-17. (See SC-17 instruction manual.)
2. Position the SB-24 so light from the flash head covers the subject.
3. Regardless of the lens in use, set the angle of coverage at the 24mm position.
4. To determine aperture, use the following equation:

$$f/\text{stop} = \frac{A}{\text{flash-to-subject-distance}}$$

Where A corresponds to the film in use according to the table below:

ISO film speed	25	32	40	50	64	80	100	125	160
A	2	2.2	2.5	2.8	3.2	3.5	4	4.4	5

ISO film speed	200	250	320	400	500*	640*	800*	1000*
A	5.6	6.3	7.1	8	8.9	10.1	11	13

*For F4, F-801/N8008, F-501/N2020 and F-301/N2000 only.

For example:

When using ISO 100 film and the flash-to-subject distance is 0.5m (1.6ft), divide 4 by 0.5 to get f/8. That means you can use an aperture of f/8 or smaller. Use the smallest aperture possible.

5. Set the flash mode selector to TTL, then turn on the SB-24 and take the shot.

- *Exposure compensation is possible with the camera's exposure compensation dial. With the Nikon F4 or F-801/N8008, it is also possible to make exposure compensation on the SB-24.*

TIPS ON SPEEDLIGHT CARE

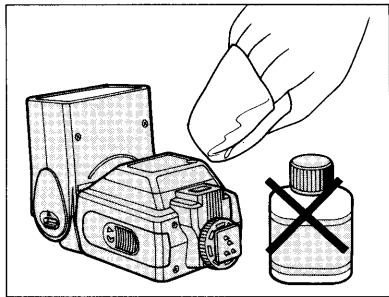

- To remove smudges, wipe with a soft, dry silicon-treated or regular cloth. Never use paint thinner, benzene, acetone or alcohol—they might damage plastic parts.

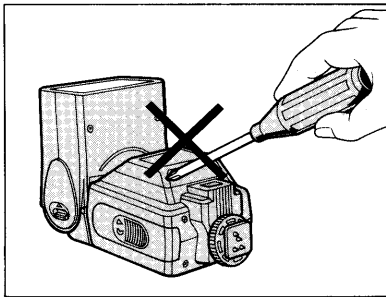

- Never disassemble or repair the flash unit; if the SB-24 malfunctions, take it immediately to an authorized Nikon dealer or service center.

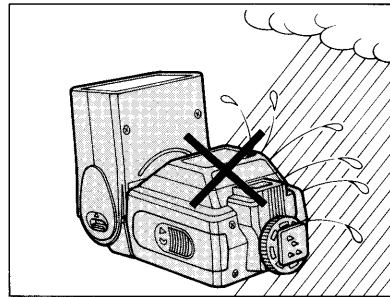

- Keep the SB-24 away from salt-water and out of the rain.

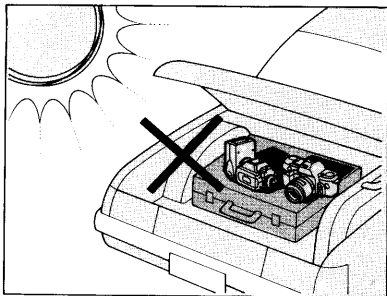

- Keep the SB-24 away from high temperatures and never store in a damp place.

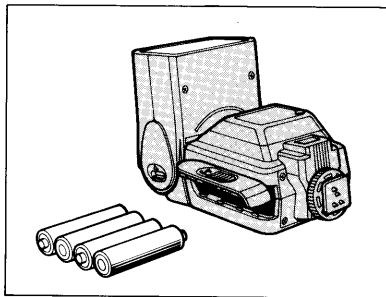

- When not using the SB-24, remove batteries to avoid damage due to battery leakage. If leakage occurs, take the SB-24 to your nearest authorized Nikon dealer.

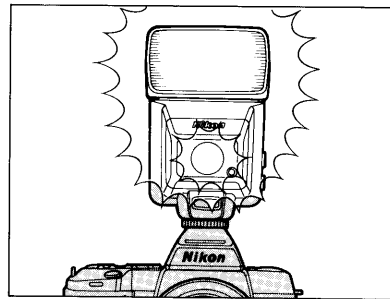

When not using the SB-24, perform the following once a month:

1. Install batteries, then turn on the SB-24.
2. Wait until the ready-light comes on.
3. Turn off the SB-24, then remove the batteries.

ABOUT BATTERIES

New batteries

Purchase the newest (freshest) batteries possible.

Temperature

Battery life ratings are based on operation at 20°C (68°F). At other temperatures, battery life is shortened. For low-temperature operation, keep spare batteries and if possible, use NiCd batteries.

Continuous use

Batteries are drained more quickly by continuous use than by intermittent use.

Storage

Store batteries in a cool, dry place below 20°C (68°F).

Battery brand

Do not mix battery brands or models, or new and old batteries.

Disposal

Do not dispose of batteries by burning, and never disassemble batteries.

NiCd batteries





Compared with regular batteries, NiCd batteries provide faster recycling time and greater efficiency at low temperatures. Before charging NiCd batteries, thoroughly read the instructions for batteries and battery charger.

Batteries with a "+" terminal exceeding 6mm in diameter cannot be used.

DC Unit SD-7

Nikon DC Unit SD-7 can be used as an optional external power source for more flash capacity and faster recycling. To use it, connect the SD-7's power cord SC-16 to the SB-24's external power terminal. Even when powered with the SD-7, the SB-24 still requires batteries inside the flash unit. Do not remove the batteries.

In continuous shooting using the external power source DC Unit SD-7, to prevent flash head deterioration caused by heat, do not exceed the maximum number of flashes as listed below.

Flash mode	Max. number of flashes
TTL auto  Non-TTL auto 	15
Manual 	15 (at full or 1/2 power) 40 (at 1/4 power or less)
Repeating flash 	10

Before firing the flash again, stop using for more than 10 minutes.

GLOSSARY

Balanced fill-flash operation

A method of flash photography which combines flash illumination and ambient light, and keeps flash brightness in balance with the ambient light.

Center-Weighted Metering

An SLR light meter, originated by Nikon, which concentrates its sensitivity on the center portion of the camera's viewing area.

CPU

Central Processing Unit: the electronic component which controls equipment functions.

Exposure compensation

For flash: exposure compensation refers to an adjustment, either automatically or manually set, that enables the user to vary the flash output from standard TTL operation.

For available light: exposure compensation refers to any adjustment of either shutter or aperture which results in an exposure change from the normal measured exposure settings.

Exposure control for available light

Programmed: the automatic exposure system controlling both the camera's shutter and the lens' aperture.

Shutter priority: user selects shutter speed and automatic system chooses aperture for correct exposure.

Aperture priority: user selects aperture and automatic system chooses shutter speed for correct exposure.

Manual: user follows the meter's recommendations for shutter and aperture settings.

Fill-flash

A method of flash photography which combines flash illumination and ambient light, but does not necessarily attempt to balance the two types of illumination.

Flash synchronization

The timing of the flash so it fires coincident with the operation of the camera's shutter. There are two types of synchronization: NORMAL, which fires the flash at the start of the exposure, and REAR synchronization, which fires the flash at the end of the exposure.

Guide number

A calculated number which indicates the relative power of a flash unit.

Hertz

Abbreviated Hz, a unit of measurement equalling one cycle per second.

LCD

Liquid Crystal Display: the visible display which shows information on the back of the SB-24 and in some camera finders.

Matrix Metering System

An advanced camera light metering system using a multi-segment sensor and computer; available in Nikon SLR models F4 and F-801/N8008. A basic version is used with the Nikon F-401/N4004 and F-401s/N4004s models. Matrix Metering is an exclusive Nikon feature.

Non-TTL Auto

A sensor measures illumination without viewing through the camera's lens.

Red-eye

A phenomena caused by the reflection of light off the inside of the eye, resulting in red spots appearing in a subject's eye in color photographs. This effect is not caused by equipment, but rather by the relative position of the flash in relation to the subject and the camera's lens. Red-eye is not always predictable.

SLR

Single Lens Reflex: a type of camera in which you look through the camera's lens as you view through the camera finder. Other camera functions, such as light meter and flash control, also operate viewing through the camera's lens.

Standard TTL flash operation

The flash output achieved when using TTL flash control for automatic flash exposure operation. This system predates balanced fill-flash systems and does not have any special provision for balancing flash and ambient light.

TTL Auto

Camera's light meter system measures illumination viewing through the camera's taking lens.

SPECIFICATIONS

All performance data are for normal-temperature operation (20°C [68°F]).

Electronic construction:

Automatic silicon-controlled rectifier and series circuitry

Guide number:

m (ft) at ISO 100

Zoom setting Light output	24mm	28mm	35mm	50mm	70mm	85mm
1/1	30 (98)	32 (105)	36 (118)	42 (138)	47 (154)	50 (164)
1/2	21 (69)	22 (72)	25 (82)	30 (98)	33 (108)	36 (118)
1/4	15 (49)	16 (52)	18 (59)	21 (69)	23 (75)	25 (82)
1/8	10.5 (34)	11 (36)	12.5 (41)	15 (49)	16.5 (54)	18 (59)
1/16	7.5 (25)	8 (26)	9 (29)	10.5 (34)	11.5 (38)	12.5 (41)

Zoom capability:

Six settings—24mm, 28mm, 35mm, 50mm, 70mm, 85mm; auto power zoom with the Nikon F-801/N8008; manually set with other cameras

Angle of coverage:

Zoom setting	Horizontal	Vertical
24mm	78°	60°
28mm	70°	53°
35mm	60°	45°
50mm	46°	34°
70mm	36°	26°
85mm	31°	23°

Bounce capability:

Flash head tilts down to -7° or up to 90° with click stops; flash head rotates through an arc of 270° , 90° clockwise and 180° counterclockwise with click stops; at front position for both vertical and horizontal angle, flash head can be locked

Power source:

Four 1.5 AA-type penlight alkaline-manganese, or 1.2V NiCd batteries; optional Battery Pack SD-7 holding six C-type batteries is available as an external power source

Power switch:

Three positions are provided—OFF, STBY (for standby) and ON; at STBY position with Nikon F4, F-801/N8008, F-501/N2020, F-401s/N4004s, F-301/N2000, FA, FE2 or FG, SB-24 turns off automatically when flash unit is not used for one or two minutes, and turns on when camera exposure meter is on

Flash duration

(approx.):

At 1/1 (full) output 1/1000 sec.
At 1/2 output 1/1100 sec.
At 1/4 output 1/2700 sec.
At 1/8 output 1/5500 sec.
At 1/16 output 1/11000 sec.

Number of flashes and recycling time at manual full light output:

Battery type	Number of flashes (approx.)*	Recycling time (approx.)
AA-type alkaline-manganese	100 times	7 sec.
AA-type NiCd	40 times	5 sec.
C-type alkaline-manganese inside the optional SD-7**	Up to 200 times Up to 300 times Up to 400 times	6 sec. 10 sec. 30 sec.

* For AF illuminator-assisted autofocus operation, less number of flashes available.

** With four AA-type penlight alkaline-manganese batteries installed in the SB-24.

Flash exposure control:

TTL mode:

Four flash modes are provided—TTL, A, M and Repeating Flash. Use with Nikon F4, F-801/N8008, F-501/N2020, F-401s/N4004s, F-301/N2000, FA, FE2 or FG; light is measured through the lens. ISO 25 to 1000 with Nikon F4, F-801/N8008, F-501/N2020 and F-301/N2000; ISO 25 to 400 with Nikon F-401s/N4004s, FA, FE2 and FG.

Usable aperture range in TTL mode:

f/1.4 to f/22 (at ISO 100)

Shooting distance range in TTL mode:

0.6—20m (2—66ft)

A mode:

For non-TTL auto flash operation, light is measured via light sensor in front of the flash unit (at ISO 100)

Usable apertures in A mode:

Shooting distance range in A mode:

0.6—20m (2—66ft)

M mode:

For manual flash operation, amount of light output can be varied in five steps

AF assist LED:

Automatically fires LED beam toward subject when performing autofocus with Nikon F4, F-801/N8008, F-501/N2020 (Single Servo) or F-401s/N4004s camera in insufficient light

Other features:

Rear-curtain sync flash photography (with F4 or F-801/N8008 only) and repeating flash photography are possible. Approx. 80 × 131 × 100mm (3.1 × 5.2 × 3.9 in.) Approx. 390g (13.7 oz.)

Dimensions

(W × H × D):

Weight (without batteries):

Accessory provided: Soft Case SS-24

Specifications and designs are subject to change without notice.